



One Camera. Dual HiRes.

Two lenses, two 5MP HiRes image sensors, up to 64 GB internal storage and a dual image of a maximum of 6 megapixels make the D15D DualDome an efficient security solution: It is possible to secure two different areas using just one camera. All without vulnerable mechanical components!



MOBOTIX D15D Dual Dome - one camera, two views (left: telephoto lens, right: wide angle lens)

HiRes

6 Megapixels

4096 x 1536
Software zoom

Skyline

Format free

Each image format
freely definable

30 Frames/s

VGA (640 x 480)
30 F/s Mega

Virtual PTZ

Digital pan, tilt,
zoom

Backlight

Safe using CMOS
without mechanical iris

Internal DVR

Internal via Flash,
external via Network

Win/Lin/Mac

Recording

via Network on PC
up to 1 Terabyte

Microphone & speaker

Audio

bi-directional via IP,
variable framerates

SIP-Client with video

IP Telephony

Alarm notify,
cam remote control

VideoMotion

Multiple windows
precision pixel-based

-22 to +140°F

Weatherproof

-30 to +60°C, IP65,
no heating necessary

IEEE 802.3af

PoE

Network power
even in winter

Robust

No moving parts
fiber glass housing

MxCC/MxEasy

Licence free

Video-Management-
Software

HiRes Video Innovations

The German company MOBOTIX AG is known as the leading pioneer in network camera technology and its decentralized concept has made high-resolution video systems cost efficient.

MOBOTIX AG • D-67722 Langmeil • Tel: +49-6302-9816-103 • Fax: +49-6302-9816-190 • sales@mobotix.com



MOBOTIX Seminars

MOBOTIX offers inexpensive seminars that include workshops and practical exercises. For more information, visit www.mobotix.com > **Seminars**.

Notes and Copyright Information

Download the latest version of this manual and the MxEasy and MxControlCenter manuals as PDF files from www.mobotix.com (**Support > Manuals**).

All rights reserved. MOBOTIX™, MxControlCenter® und MxEasy® are internationally protected trademarks of MOBOTIX AG. Microsoft, Windows and Windows Server are registered trademarks of Microsoft Corporation. Apple, the Apple logo, Macintosh, OS X and Bonjour, the Bonjour logo and the Bonjour icon are trademarks of Apple Inc. Linux is a trademark of Linus Torvalds. All other marks and names mentioned herein may be trademarks or registered trademarks of the respective owners.

Copyright © 1999-2013 MOBOTIX AG, Langmeil, Germany. Information subject to change without notice!

CONTENTS

1	Product Overview	10
1.1	D15D-DualDome	10
1.1.1	General Product Characteristics	10
1.1.2	Advantages And New Features	15
1.1.3	Decentralized Video System	17
1.1.4	Green IP Video	19
1.2	Technical Specifications	20
1.2.1	Lens Options	20
1.2.2	Camera Variants – Lenses, Hardware, Image Formats	22
1.2.3	Camera Variants – Software Features	24
1.2.4	Technical Data	26
1.3	Delivered Parts	28
1.3.1	Standard Delivery – D15D	28
1.3.2	Standard Delivery – D15D-Pano	30
1.3.3	Standard Delivery – D15D-Sec-DNight-Fix	32
1.3.4	Delivered Parts For The Outdoor Wall Mount (Accessory)	34
1.3.5	Delivered Parts For The Corner And Pole Mount (Accessory)	35
1.4	Available Accessories	36
1.4.1	NPA-PoE-Set	36
1.4.2	Replacement Dome	36
1.4.3	Vandalism Set	36
1.4.4	Ethernet Patch Cable With Bayonet Catch	37
1.4.5	Outdoor Wall Mount	37
1.4.6	Corner and Pole Mount	37
1.4.7	MX-Patch-Box	37
1.4.8	MX-NPA-Box	38
1.4.9	MX-GPS-Box	38
1.4.10	MX-232-IO-Box	38
1.4.11	ExtIO Expansion Module	39
1.4.12	Mx2wire+ Media Converter	39
1.4.13	MiniUSB Cable To MiniUSB (Straight/Straight Or Straight/Angled)	39
1.4.14	MiniUSB Cable To USB A Socket	39
1.5	MOBOTIX Software	40
1.5.1	Integrated Camera Software (Firmware)	40
1.5.2	MxControlCenter	41
1.5.3	MxEasy	42
1.5.4	MOBOTIX App	43
2	Mounting	44
2.1	Overview Of Mounting Options	44
2.1.1	Mounting Indoor Cameras To A Ceiling Or Wall (Without Accessories)	44
2.1.2	Outdoor Installation On A Wall, Pole Or Corner (With Accessories)	45

2.2	Overview Of Network Connection	46
2.2.1	Power-Over-Ethernet (PoE Conforming To IEEE 802.3af)	46
2.2.2	Uninterruptible Power Supplies (UPS)	47
2.2.3	Preparing The Camera Connections, Wall Outlets	47
2.2.4	Wiring, Fire Prevention, Lightning And Surge Protection	48
2.3	First Installation Steps	50
2.3.1	Mounting Lens Units	50
2.3.2	Overview Of Cable Connections	54
2.3.3	Connecting The Ethernet Cable With The MX-Patch-Box	55
2.3.4	Connecting The MiniUSB Cable	55
2.3.5	Connecting MxBus Modules	57
2.3.6	Replacing The MicroSD Card	58
2.4	Mounting The Camera With Outdoor Wall Mount	60
2.4.1	Aiming The Passive Infrared Sensor (PIR)	60
2.4.2	Mounting The Outdoor Wall Mount	61
2.4.3	Aiming The Camera	63
2.4.4	Connecting The Camera With Bottom Plate	64
2.4.5	Connecting And Securing The Camera	65
2.5	Mounting The Corner And Pole Mount	66
2.5.1	Overview	66
2.5.2	Mounting To The Corner Of A Building	67
2.5.3	Mounting To A Pole	68
2.5.4	Mounting The Outdoor Wall Mount	69
2.6	Adjusting The Lens	70
2.7	Network And Power Connection	71
2.7.1	Notes On Cable Lengths And Power Supply	71
2.7.2	Power Supply With Power-Over-Ethernet Products	71
2.7.3	Power Supply Using A Switch	72
2.7.4	Power Supply When Connected Directly To A Computer	73
2.7.5	Variable PoE	74
2.7.6	Camera Startup Sequence	75
3	Operating The Camera	76
3.1	Manual And Automatic Operation – Overview	76
3.1.1	Manually Using A Computer In The 10.x.x.x IP Address Range	77
3.1.2	Automatically Using MxControlCenter Or MxEasy	78
3.1.3	Automatically Using DHCP	79
3.2	First Images And The Most Important Settings	80
3.2.1	Manually Setting Up The Network Parameters In A Browser	80
3.2.2	First Images And The Most Important Settings In The Browser	82
3.2.3	First Images And Network Parameter Configuration In MxControlCenter	84
3.2.4	First Images And Network Parameter Configuration In MxEasy	89
3.2.5	Starting The Camera With The Factory IP Address	92
3.2.6	Starting The Camera With An Automatic IP Address (DHCP)	93

3.3	Virtual PTZ And Full Image Recording	94
3.3.1	Virtual PTZ	94
3.3.2	Full Image Recording	96
3.4	Image Optimization	98
3.4.1	Correction Of Lens Distortion (L25 Only)	98
3.4.2	Adjusting The Panorama Image (D15D-Pano Only)	100
3.4.3	Dual Image Exposure	105
3.5	MicroSD Card Recording	106
3.5.1	Introduction	106
3.5.2	Formatting The MicroSD Card	108
3.5.3	Activate Recording	109
3.5.4	Accessing Data on the MicroSD Card	110
3.5.5	Deactivating Card Recording	110
3.5.6	Using A MicroSD Card In A Different MOBOTIX Camera	111
3.5.7	Limitations On Warranty When Using Flash Storage Media	111
3.6	Configuration In The Browser	112
3.6.1	Overview	112
3.6.2	General Browser Settings	114
3.7	Additional Notes	116
3.7.1	Password For The Admin Menu	116
3.7.2	Permanently Deactivating The Microphone	116
3.7.3	Starting The Camera With The Factory IP Address	116
3.7.4	Resetting The Camera To Factory Settings	116
3.7.5	Activating Event Control And Motion Detection	117
3.7.6	Deactivating Text And Logo Options	117
3.7.7	Deactivating The Camera Reboot	117
3.7.8	Browser	117
3.7.9	Cleaning The Camera And Lens	118
3.7.10	Safety Warnings	118
3.7.11	Online Help In The Browser	119
3.7.12	RoHS Declaration	119
3.7.13	Disposal	119
3.7.14	Disclaimer	119
	Declaration of Conformity D15D-DualDome	122
	Manufacturer	123



Important Notes

Electrical Installation

Electrical systems and equipment may only be set up, changed and maintained by a qualified electrician or under the direction and supervision of a qualified electrician in accordance with the appropriate electrical guidelines.

Legal Aspects Of Video And Sound Recording

You must comply with all data protection regulations for video and sound monitoring when using MOBOTIX products. Depending on national laws and the installation location of the IP Video Door Station, the recording of video and sound data may be subject to special documentation or it may be prohibited. All users of MOBOTIX products are therefore required to familiarize themselves with all valid regulations and comply with these laws. MOBOTIX AG is not liable for any illegal use of MOBOTIX products.

Network Security

MOBOTIX products include all of the necessary configuration options for operation in Ethernet networks in compliance with data protection laws. The operator is responsible for the data protection concept across the entire system. The basic settings required to prevent misuse can be configured in the software and are password-protected. This prevents unauthorized parties from accessing these settings.



D15D Standard

Image sensors and lenses can be combined freely and you can point the image sensors into different directions, totally independent from one another..



D15D-Pano

Two super wide-angle lenses mounted on a bracket deliver a high-resolution panorama image with up to 6 megapixels that is distortion-corrected by the camera software.



D15D-DNIGHT

The camera switches lenses automatically, depending on the current illumination: either the color image sensor with daylight lens or the B/W image sensor with infra-red lens.

FOREWORD

Dear MOBOTIX customer,



Congratulations on your purchase of the latest generation of the successful MOBOTIX DualDome cameras. The D15D is a high-resolution, weatherproof network camera "Made in Germany". The D15D can capture two different areas at once in great detail, thanks to its two lenses with sensor assembly and optimized sensor technology.

The latest 5-megapixel image sensor technology used in the camera guarantees brilliant 2 x 3.1 megapixel dual images. The camera's enhanced light sensitivity allows it to produce convincing color images even in low-light situations. Likewise, you only need one of the optional, new black and white sensors to deliver HiRes images of up to 3.1 megapixel resolution at night – either live or recorded (D14D: 1.3 megapixels).

Using a weatherproof MxBus and MiniUSB camera interfaces allow MOBOTIX interface boxes and standard modules such as UMTS or storage devices to be connected directly. The camera's 4 GB internal flash memory, which offers sufficient space for long-term recordings, can be individually extended simply by changing the MicroSD card.

This Camera Manual provides you with all the information you need to be able to unpack and install the camera and view initial images on a PC. For information on how to work with the many camera functions, such as event control or image storage, please refer to the online help for the camera in the browser (see *Section 3.7.11*).

The **MxEasy** and **MxControlCenter** video management software, specifically developed for MOBOTIX cameras, is available for free download from the MOBOTIX website (with the manual as a PDF): www.mobotix.com > **Support** > **Software Downloads**. MOBOTIX also provides a mobile solution for the iPad, iPhone and iPod Touch mobile iOS devices. Search for "MOBOTIX AG" in the App Store to find the free app.

If you have any questions, our support and international sales staff are available at intl-support@mobotix.com from Monday to Friday, 8 am to 6 pm (German time).

Thank you for choosing MOBOTIX products and services. We wish you all the best with your new, high-performance MOBOTIX D15D DualDome camera!

Security-Vision-Systems



© MOBOTIX AG • Security-Vision-Systems • Made in Germany

www.mobotix.com • sales@mobotix.com



1 PRODUCT OVERVIEW

1.1 D15D-DualDome



1.1.1 General Product Characteristics

HiRes DualDome Camera With Two Independent Image Sensors And Lenses

With its compact and elegant dome-shaped housing, the MOBOTIX DualDome camera system has become an indispensable feature of the now global market of high-resolution network security cameras. Thanks to the flexibility of two adjustable lenses and optional HiRes image sensors, this camera system delivers video surveillance of one scene in day and night mode (DNight models) or it can monitor two different areas simultaneously using different day or night lenses.

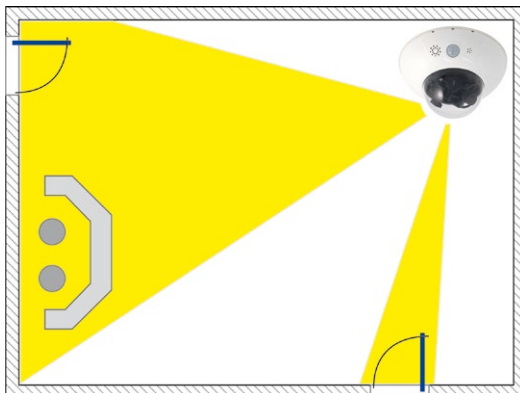

One camera monitors two different image areas

5-Megapixel Image Sensor Technology

The D15D features an increased level of performance compared to the previous D14D model. The latest 5-megapixel image sensor technology used in the camera has improved the frame rate as well as the image quality for up to 3.1 megapixel resolution and brings a new level of detail to your zoomed images (+26%). Thanks to the new sensors that feature close to four times higher light sensitivity, the camera also delivers convincing color images at dusk and in heavy rainfall. At night, the optional black and white sensor now also provides HiRes images of up to 3.1 megapixel resolution (previous D14D model: max. 1.3 megapixels), delivering dual images at up to six megapixels during both day and night.



Overview And Details With A Single Camera

A single D15D is all that is required to fully monitor an entire shop floor, as well as provide a direct view of the checkout. The simultaneous generation and evaluation of two images with a high degree of image detail not only reduces the number of required cameras, but also minimizes system costs by reducing the wiring complexity, backup power supply requirements and number of recording devices required.

All D15D cameras feature direct recording to integrated MicroSD cards (up to 64 GB) or external USB drives and can therefore be used in standalone operation with no additional network load.

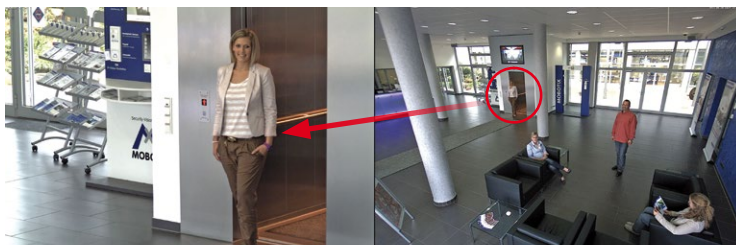

Robust, Practically Maintenance-Free And Versatile

Its robust design means that the D15D can be installed on walls or ceilings without any additional accessories in locations where the already very high requirements of the IP54 protection class are sufficient.

Ambient temperatures may vary between -30 to $+60^{\circ}\text{C}$ / -22 to 140°F , making it the ideal camera for the most demanding weather situations. From stations in Antarctica to production monitoring at a steel smelting plant, MOBOTIX cameras offer unmatched flexibility and versatility.

The absence of mechanically moving parts, heating and ventilation means that D15D cameras require less than five watts of power. This can be easily supplied via a standard PoE cable. Cleaning the D15D is simple enough: wipe the dome using a lint-free cotton cloth and a mild household detergent without abrasive particles.

Model Variants And Lenses

The D15D is available as a Secure or IT variant, each of which has two day or night sensors or a day/night sensor combination. The main difference between Secure and IT models is that the two image sensors of the Secure models have a higher maximum resolution (two 3MEGA instead of two VGA). Each D15D comes with a well-protected, pre-installed 4 GB MicroSD card as standard. If required, this card can be replaced with a card of up to 64 GB. The night models of the D15D with two highly sensitive black and white image sensors deliver high-contrast images of up to six megapixels in size even in extremely low-light conditions.

D15D: Individual Lens Configuration

The standard models of the D15D stand out in particular as they allow the two image sensors and lenses to be combined as required and focused on different areas independently of one another. A lens can be delivered for every day or night sensor with a horizontal image angle of 13° , 27° , 39° , 54° and 82° as desired.

Detail and overview
in dual image mode

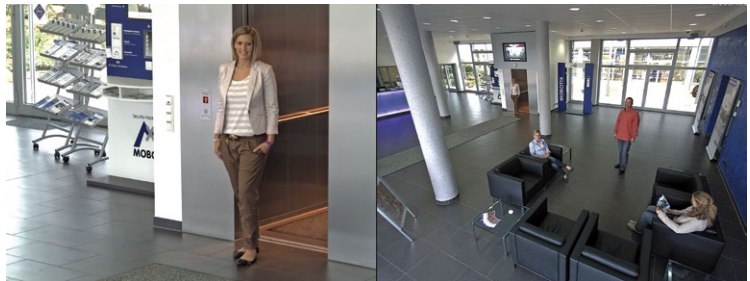

Note

The lenses must be ordered separately for standard versions and can be attached to the camera housing in just a few steps (see *Chapter 2, «Mounting»*). Special D15D-DNight-Fix and D15D-Pano versions of the camera are also available. The lenses in these special versions are pre-installed at the MOBOTIX factory on special lens bridges.

D15D-Pano: High-Resolution Panoramic View

The D15D-Pano is equipped with a panorama lens bridge with two permanently installed Super Wide-Angle lenses. Together, they provide a high-resolution panorama image that is up to six megapixels in size, which is corrected by means of the camera software.

Using only one camera, it is possible, for example, to cover one side of a building and the adjacent areas (parking lots, lawns, etc.). The D15D-Pano also delivers excellent, detailed images as a high-quality webcam.



Panorama dual image with up to six megapixels during the day (color) and at night (black and white)

D15D-DNight-Fix: 3MEGA Images By Day And By Night

The day/night version of the D15D is equipped with two different image sensors including two lenses. It automatically switches to the ideal mode depending on the lighting conditions: either the color sensor with daylight lens or the black and white sensor with infrared lens.

This dual sensor system provides excellent true-color images during the day (also in reduced daylight) and extremely sensitive night images in dark environments. A new feature of the D15D is the maximum resolution of the black and white sensor, which has increased from 1.3 to 3.1 megapixels.

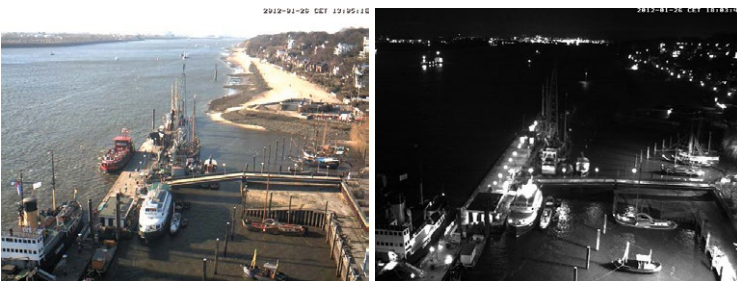

Automatic day/night switching depending on lighting conditions

The day and night lenses are pre-installed at the factory on a special DNight lens bridge, which ensures that they are positioned exactly parallel to one another. This way, the day lens always covers the same area as the night lens.

D15D with vandalism set: Suitable for use in particularly harsh conditions (only the stainless steel ring can be used for the D15D-Pano and D15D-Sec-DNight-Fix)



D15D With Vandalism Set (Accessory)

In critical environments or particularly harsh outdoor conditions, a MOBOTIX camera with optional anti-vandalism features is often the best choice. Their steel housing resists even the hardest attacks, and the cameras will deliver a perfect picture of the attackers.



D15D With Outdoor Wall Mount (Accessory)

When combined with the Outdoor Wall Mount, which is available as an accessory, the D15D is compliant with the higher IP65 protection class (fully dustproof and resistant to water jets) and can then be easily used in any unprotected outdoor areas. MOBOTIX offers an additional Corner and Pole Mount that allows the Outdoor Wall Mount to be attached to the corners of buildings and to masts.

The Outdoor Wall Mount's design enables, for example, WiFi or GSM/UMTS modules to be installed directly within the weatherproof housing without disturbing the overall appearance of the surveillance unit. Similarly, relays for alarm sirens or lights can be installed easily and elegantly within the housing.

The Outdoor Wall Mount is made from PBT-30GF (polyethylene terephthalate with 30% fiberglass). This material, which is often used in the automotive industry, is stable and resistant to high temperatures, UV rays, other environmental factors, chemicals, etc. The software-based architecture of the MOBOTIX D15D and free software updates ensure that the surveillance system has a long product life and thus provides a high return on investment.



1.1.2 Advantages And New Features

The high-resolution D15D-DualDome camera is the even more powerful successor to the D14D and is the first MOBOTIX camera to feature five-megapixel image sensors. Due to technical reasons, the maximum size at which the images of a D15D sensor can be displayed is 3.1 megapixels (live or recorded). Despite this, the D15D outperforms the previous D14D model and other dome cameras on the market in many respects.

Smooth HiRes Video Streams

The modified hardware of the D15D ensures that the video streams of the camera are transmitted even more smoothly than those of the high-performance D14D, particularly at high resolutions. As image streams from a rate of 16 frames per second are perceived by the human eye as continuous movement, the maximum frame rate remains limited to 30 fps (for MEGA resolution 1280x960) to ensure that sufficient camera processing power is available for other tasks.

Conclusive Still Images

Thanks to the proprietary MxPEG video codec developed exclusively for MOBOTIX cameras, the cameras offer the advantage that a recording can be paused at any given point and still provide meaningful and useful snapshots due to the absence of distortion. This is essential for security applications and allows individuals or license plates to be identified, for example. In contrast, the H.264 standard, which was developed for feature movies and is favored by some video security providers, cannot achieve this with the required level of quality.

Good Color Images Even In Low Light

The more light-sensitive an image sensor is, the better the image quality, especially when the ambient light level is low, such as at dusk and in heavy rainfall. The D15D offers the best MOBOTIX image quality that is currently available thanks to the light sensitivity provided by the five-megapixel color sensor that is four times higher than that of the previous three-megapixel color sensor.

More Details When Zooming

The maximum zoom factor of the D15D is 1.26 times higher than that of the D14D due to the use of five-megapixel technology. This means that the degree of detail provided by the camera has improved by 26 percent. As a result, a D15D can now be installed even further away than before from the objects and areas to be monitored. In addition, this relativizes the horizontal image angles of the new five-megapixel sensors that are slightly smaller compared to the D14D.

Black And White Resolution Now Up To 3.1 Megapixels

The D15D is the first MOBOTIX camera worldwide to also feature a five-megapixel night sensor that can deliver black and white images of up to 3.1 megapixel resolution. This means that in pixels alone images are roughly 140% larger than those delivered by the

previous 1.3-megapixel sensor. The images also benefit from the improved detail magnification enabled by digitally zooming into the image created by the five-megapixel sensor.

MxActivitySensor

The D15D provides an activity-controlled image analysis sensor as standard for detecting the movements of people and objects in a defined surveillance area (full image or section). The MxActivitySensor delivers reliable results particularly in outdoor area applications, in contrast to video motion detection that continues to be available and that registers all image changes in defined video motion windows. In the monitored area, the camera distinguishes between the continuous movements of vehicles, persons or objects that trigger an alarm and movements that do not set off an alarm such as shadows, changing light conditions and trees swaying in the wind.

Low Power Consumption In Accordance With The PoE Standard (IEEE 802.3af)

A D15D uses no more power than its predecessor (typically 4.5 watts), despite the new sensor technology. Adjusting the PoE class via the camera software also enables the use of PoE switches that cannot be operated on all ports with PoE class 3 (up to max. 12.95 V).

1.1.3 Decentralized Video System

Usually, cameras only supply images while processing and recording take place later on a central PC using video management software. This centralized structure has too many limitations for high-resolution video systems since it requires high network bandwidth and the PC processing power is insufficient when using several high-resolution cameras. Due to the large number of computers and servers required, traditional centralized systems are therefore becoming less suitable and cost effective.

As part of the decentralized MOBOTIX concept, every camera features a **high-speed processor**, and, if necessary, digital **long-term flash memory** (MicroSD card) can be integrated to provide several days of recording time. The computer or video control center is required only to view and control the cameras, not to evaluate and record video. This means that you do not have to rely on expensive, overloaded video management software as most of the important functions that require a large amount of processing power are integrated into the MOBOTIX cameras themselves.

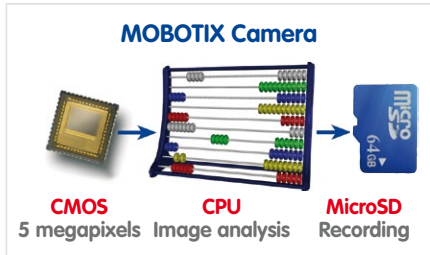

Integrated Sensors enable MOBOTIX cameras such as the D15D to automatically detect when an event has occurred. If necessary, the cameras will respond immediately with an alarm sound and will establish a direct video and sound connection to a control room.

The D15D is equipped with a **shock detector** as standard (for all IT and Secure models). For example, if the camera receives a blow to the housing, it can simultaneously take a video of the offender, trigger a sound alarm and notify the security company via a SIP call. Due to the build quality and absence of moving parts, MOBOTIX cameras are extremely tough. This typically allows them to stay fully operational, even when they are subject to strong vibrations.

All MOBOTIX cameras are **backlight-proof** and are not adversely affected by the glare from direct sunlight. They deliver meaningful, detailed images at all times as the camera software supports easy programming of independent exposure windows, making them ideal for rooms with large glass fronts.

MOBOTIX In the event of an alarm, D15D cameras can also record **lip-synchronous audio**. The cameras therefore play an important role in analyzing and clarifying a situation. An integrated speaker and microphone allow each camera to also be used for **bidirectional communication** (two-way video communication). This feature is also available on the move using the MOBOTIX App on an iPhone or iPad.

The **decentralized MOBOTIX video solutions** are superior to traditional systems in all major aspects. They are also considerably cheaper to operate since they require

- **Fewer cameras** due to the more accurate detail of panorama images with mega-pixel technology
- **Fewer recording devices** because in the decentralized system, ten times the standard number of cameras can be used to record high-resolution HDTV video with sound on one computer/server simultaneously
- **Lower network bandwidth** because everything is processed in the camera itself and the high-resolution images therefore do not have to be constantly transported for analysis



MOBOTIX System

Decentralized and secure



Recording software



PC as storage device

1.1.4 Green IP Video

The modern, network-based video security technology offers numerous advantages to use energy efficiently. Due to the special product and system properties, the decision to install MOBOTIX video systems is also a decision for Green IP Video: low power consumption and environmental friendly because of long life expectancy and minimal amount of materials involved.

Low Power Consumption

MOBOTIX cameras are cost-efficiently supplied via PoE. This reduces the expenses for power and, in addition, saves copper and other important raw material as less power cabling is necessary.

Robust

MOBOTIX IP65 cameras are highly robust and work – without high-power climate control and extra protective housing – in a temperature range from –30 to +60°C/–22 to +140°F.

Modern

Integrated into the cameras are high-power processors and flash storage, thus making energy-consuming servers and storage devices unnecessary. And, of course, the disposal of waste later.

High Resolution

A hemispheric MOBOTIX camera with two image sensors replaces up to eight standard cameras – including their consumption of energy and resources.

Sustainable

Without mechanical components, MOBOTIX cameras are maintenance-free and stay fully functional, even after years – and are, thus, more sustainable compared to other systems.

Forward-Looking

Even previous camera models can be easily updated and then offer new functionalities. Remote updates via the internet and the fact that the cameras are maintenance-free reduce trips by car, and, thereby, the negative effect on the environment.



1.2 Technical Specifications

1.2.1 Lens Options

MOBOTIX currently offers five standard lenses with M14 thread for the D15D that can each be combined with a day or night sensor (color or black and white). Since **MOBOTIX cameras are backlight-proof, none of these lenses requires a mechanical auto iris.** This makes the cameras extremely robust and maintenance-free.

The **L25 Super Wide-Angle lens** has very little distortion and delivers good image quality, even when the maximum digital zoom is used. If the D15D is mounted in the corner of a room with this lens, the complete room will be visible on the image.

MOBOTIX Original image
L25 Super Wide-Angle



In the case of the special D15D-Pano model, two L25 lenses are installed in such a way that the camera can optically combine the two 82° images via the software to form a single large and corrected panorama image.

D15D With Standard Lenses And M14 Thread

Five different MOBOTIX lenses are available for every sensor unit:

- L25 Super Wide-Angle with 82° image angle (horizontal)
- L38 Wide Angle with 54° image angle (horizontal)
- L51 Wide Angle with 39° image angle (horizontal)
- L76 Telephoto with 27° image angle (horizontal)
- L160 Telephoto with 13° image angle (horizontal)

This results in a **total of 20 possible lens combinations** (L25/L25 to L160/L160) for a D15D.



Five-Megapixel Sensor Lenses	L25	L38	L51	L76	L160
Original image					
35 mm equivalent	25 mm	38 mm	51 mm	76 mm	160 mm
Nominal focal length	4 mm	6 mm	8 mm	12 mm	25 mm
Aperture	2.0	2.0	2.0	2.0	2.5
Horizontal image angle	82°	55°	40°	27°	13°
Vertical image angle	61°	41°	30°	20°	10°
At 1 m distance					
Image width	1.7	1.0	0.7	0.5	0.2
Image height	1.2	0.7	0.5	0.4	0.2
At 5 m distance					
Image width	8.7	5.2	3.6	2.4	1.1
Image height	5.9	3.7	2.7	1.8	0.9
At 10 m distance					
Image width	17.4	10.3	7.2	4.9	2.3
Image height	11.9	7.5	5.4	3.6	1.7
At 20 m distance					
Image width	34.7	20.6	14.5	9.7	4.6
Image height	23.7	14.9	10.8	7.2	3.4
At 50 m distance					
Image width	86.8	51.5	36.2	24.3	11.4
Image height	59.3	37.3	27.0	18.0	8.6

Notes

The specified focal lengths of the MOBOTIX lenses do not reflect the actual focal length of the lenses, but the focal length (Lxx mm) converted to 35 mm camera format. For example, the MOBOTIX L25 Super Wide-Angle lens has an actual focal length of 4 mm. This would be the equivalent of 25 mm on a 35 mm camera. It is therefore referred to as an L25. Since the image sensors in digital cameras have different sizes, converting the focal lengths to 35 mm camera as a known format allows the image formats and the fields of vision of the different lenses to be calculated and compared more easily. Another benefit is that you can easily set a 35 mm camera (analog or digital) to the same focal length as the MOBOTIX lens (Lxx) to obtain the same field of vision. This approach greatly facilitates lens selection.





1.2.2 Camera Variants – Lenses, Hardware, Image Formats

Camera Model				
	D15Di-IT (Day)	D15Di-IT-Night	D15Di-Sec (Day)	
Lenses, Sensors				
Hemispheric 12 mm	–	–	–	
Super Wide-Angle 25 mm	L25	L25	L25	
Wide-Angle 38 mm	L38	L38	L38	
Wide-Angle 51 mm	L51	L51	L51	
Tele 76 mm	L76	L76	L76	
Tele 160 mm	L160	L160	L160	
CSVario 24–54 mm	–	–	–	
Image sensor with individual exposure zones	Color, color	B/W, B/W	Color, color	
Sensor sensitivity in lux at 1/60 s / 1 s	0.25 / 0.013	0.05 / 0.0025	0.25 / 0.013	
Hardware Features				
Protection classes	IP54/IP65*/IP66**/IK10**			
Temp. internal DVR (MB)	32	32	64	
Internal DVR (MicroSD, up to 64 GB)	4 GB incl.	4 GB incl.	4 GB incl.	
Microphone/speaker	X/X	X/X	X/X	
Passive infrared sensor (PIR)	X	X	X	
Integrated temperature sensor	X	X	X	
Shock detector	X	X	X	
Power consumption in watts (typical)	< 5	< 5	< 5	
Variable PoE class	2 – 3	2 – 3	2 – 3	
Image Formats, Frame Rates and Image Storage				
Max. resolution (per sensor)	HD (1280x720)	HD (1280x720)	3MEGA (2048x1536)	
Max. frame rate (MxPEG, max. resolution)	30 B/s	30 B/s	20 fps	
CIF images with 4 GB MicroSD DVR	250,000	250,000	250,000	
VGA images with 4 GB MicroSD DVR	125,000	125,000	125,000	
MEGA images with 4 GB MicroSD DVR	–	–	40,000	
3MEGA images with 4 GB MicroSD DVR	–	–	20,000	

*With Outdoor Wall Mount



**With Vandalism Set

				
	D15Di-Sec-Night	D15Di-Sec-Pano	D15Di-Sec-Night-Pano	D15Di-Sec-DNight-Fix
Lenses, Sensors				
	-	-	-	-
	L25	L25	L25	L25
	L38	-	-	L38
	L51	-	-	L51
	L76	-	-	L76
	L160	-	-	L160
	-	-	-	-
	B/W, B/W	Color, color	B/W, B/W	Color, B/W
	0.05/0.0025	0.25/0.013	0.05/0.0025	0.25/0.013 / 0.05/0.0025
Hardware Features				
	IP54/IP65*/IP66**/IK10**	IP54/IP65*/IP66**		
	64	64	64	64
	4 GB incl.	4 GB incl.	4 GB incl.	4 GB incl.
	X/X	X/X	X/X	X/X
	X	X	X	X
	X	X	X	X
	X	X	X	X
	< 5	< 5	< 5	< 5
	2 – 3	2 – 3	2 – 3	2 – 3
Image Formats, Frame Rates and Image Storage				
	3MEGA (2048x1536)	3MEGA (2048x1536)	3MEGA (2048x1536)	3MEGA (2048x1536)
	20 fps	8 fps	8 fps	20 fps
	250,000	250,000	250,000	250,000
	125,000	125,000	125,000	125,000
	40,000	40,000	40,000	40,000
	20,000	20,000	20,000	20,000

*With Outdoor Wall Mount

**With Vandalism Set

1.2.3 Camera Variants – Software Features

Camera Model			
	D15Di-IT (Day)	D15Di-IT-Night	D15Di-Sec (Day)
General Features			
Digital zoom (continuous) with panning	X	X	X
Motion JPEG/MxPEG/H264 codecs	X/X/–	X/X/–	X/X/X
Programmable exposure ones	X	X	X
Snapshot rec. (pre-/post-alarm images)	10	10	50
Terabyte ring buffer storage (internal/network)	X	X	X
Continuous rec. with sound (0.2 to 30 fps)	X	X	X
Event recording with sound	X	X	X
Time and event control	X	X	X
Weekly schedules/holidays	X	X	X
Web functionality (FTP, email)	X	X	X
Playback/Quad und MultiView, bidirectional sound in browser	X	X	X
Logo generator, animated	X	X	X
Flexible event logic	–	–	X
Master/Slave arming	–	–	X
Several scheduled privacy zones	–	–	X
Customized voice messages	X	X	X
VoIP telephony (audio/video, alert)	X	X	X
Remote alarm notification (network msg.)	X	X	X
Signal inputs/outputs, RS232	Via MX-232-IO-Box		
Programming interface/HTTP API	X	X	X
Security features (HTTPS/SSL, IP-based access control, IEEE 802.1X network authentication)	X	X	X
Video Analysis			
Video Motion detector	X	X	X
MxAnalytics	–	–	–
MxActivitySensor	–	–	X
Video Management Software			
MxEasy, MxCC	X	X	X
MOBOTIX App	X	X	X

Free-of-charge
download from
www.mobotix.com
or App Store

1.2.4 Technical Data

Technical Data D15D	
Model variants (fitted with day or night sensors)	MX-D15Di-IT, MX-D15Di-SEC (day or night), MX-D15Di-SEC-DNIGHT-FIX (day and night), MX-D15Di-SEC-Pano (Day) MX-D15Di-SEC-NIGHT-Pano (night)
Lens options	25 to 160 mm (compared to 35 mm camera), horizontal angle 82° to 13°
Sensitivity	Color sensor: 0.25 lux at 1/60 s, 0.013 lux at 1 s Black and white sensor: 0.05 lux at 1/60 s, 0.0025 lux at 1 s
Image sensors	Two 1/2.5" CMOS, 5 megapixels, progressive scan
Max. image resolution D15Di-IT (dual image)	Color: 2560x720 (dual HD) Black and white: 2560x720 (dual HD)
Max. image resolution D15Di-SEC (dual image)	Color: 4096x1536 (6MEGA) Black and white: 4096x1536 (6MEGA)
Image formats (per sensor)	Selectable image formats, for example, 2048x1536 (MEGA), 1920x1080 (full HD), 1280x960 (MEGA), 1280x720 (HD), 1024x768, 800x600, 768x576 (D1-PAL), 704x576 (TV-PAL), 640x480, 384x288, 320x240, 160x120
Max. frame rate (M-JPEG) (live/recording)	VGA: 30 fps, MEGA: 10 fps, 3MEGA: 4 fps, 6MEGA: 2 fps
Max. frame rate (MxPEG) (live and recording including sound)	VGA: 30 fps, MEGA: 30 fps, 3MEGA: 20 fps, 6MEGA: 8 fps
Image compression	MxPEG, M-JPEG, JPEG, H.264
Internal DVR	MicroSD slot including 4 GB, max. 64 GB
External video ring buffer	Directly on NAS and computer/server without additional recording software
Software (included)	MxEasy video management software, MxControlCenter control center software, MOBOTIX App for iOS devices, iOS 5.0 and higher
Image processing	Backlight compensation, automatic white balance, image distortion correction, panorama correction, Video Motion detection, MxActivitySensor,
Virtual PTZ	Digital pan/tilt/zoom, continuous 8X zoom
Alarm/events	Video Motion detection, MxActivitySensor, external signal, temperature sensor, PIR, microphone, shock detector, notification over e-mail, FTP, IP telephony (VoIP, SIP), visual/acoustic alarm, pre- and post-alarm images
Microphone and speaker	Integrated microphone and speaker
Sound	Lip-synchronous audio, two-way communication, sound recording

Functionality depends on camera variant (see Section 1.2.3, «Camera Variants - Software Features»!)

Technical Data D15D	
Interfaces	10/100 Ethernet, MiniUSB, MxBus; inputs and outputs and RS232 via accessories
Video telephony	VoIP/SIP, two-way communication, remote controlling with key code, event notification
Security	User/group management, HTTPS/SSL, IP address filter, IEEE 802.1x, intrusion detection, digital image signature
Certifications	EMV (EN 55022, CISPR 22, EN 55024, EN 61000-6-1/2, FCC Part15B, CFR 47, AS/NZS 3548)
Power supply	Year-round Power-over-Ethernet (IEEE 802.3af); variable PoE class, approx. 5 W
Protection classes	IP54 without wall mount IP65 with wall mount IP66 and IK10 with Vandalism Set
Temperature range	-30 to +60°C/-22 to +140°F
Dimensions/weight	Diam. x H: 205 x 108 mm (D15D), 205 x 125 mm (D15D-Pano, D15D-Sec-DNight-Fix); weight: approx. 750 g (including lenses)
Delivered parts	Housing (high-resistance composite, PBT-PC), white, shock-resistant dome (transparent), free choice of lens, mounting parts, Allen wrench, 50 cm patch cable, manual, software, 4 GB MicroSD card



1.3 Delivered Parts

1.3.1 Standard Delivery – D15D



Item	Number	Part Name
1.1	1	Camera housing
1.2	2	Lens (installed)
1.3	2	Lens mount
1.4	2	Lock ring (installed)
1.5	2	Sensor cable (integrated, not shown here)
1.6	1	Cable cover (installed)
1.7	2	Dome (1x transparent – integrated, 1x tinted)
1.8	1	Outer shell
1.9	1	Ethernet cable (installed)
1.10	1	Allen wrench 3 mm
1.11	1	TX20 Torx wrench
1.12	1	Custom tool with magnet
1.13	1	MxBus connector (inserted):
1.14	1	MicroSD card, max. of 4 GB (inserted)

Installation accessories

Item	Number	Part Name
M.1.1	3	8-mm screw anchors
M.1.2	3	Stainless steel washers, diam. 5.3 mm
M.1.3	3	Stainless steel wood 4.5 x 60 mm screws with TX20 head

Camera Housing And Connectors – D15D

The MOBOTIX D15D consists of three main components (camera housing, outer shell and dome).

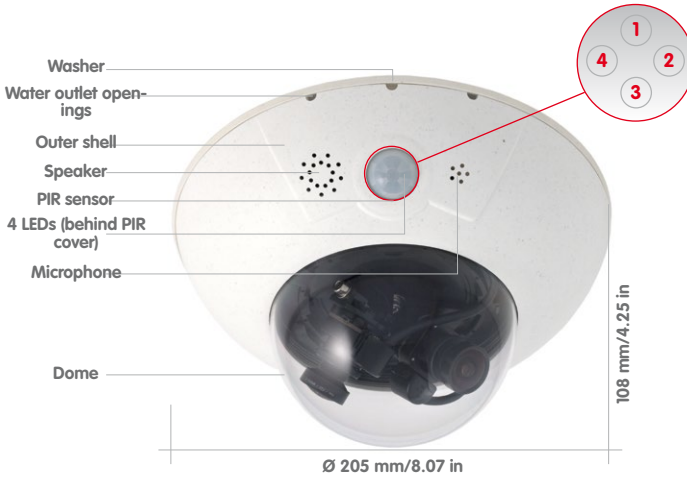

LED default settings:
1 Power (on), error (flashes)
2 Recording (flashes)
3 Off
4 Off

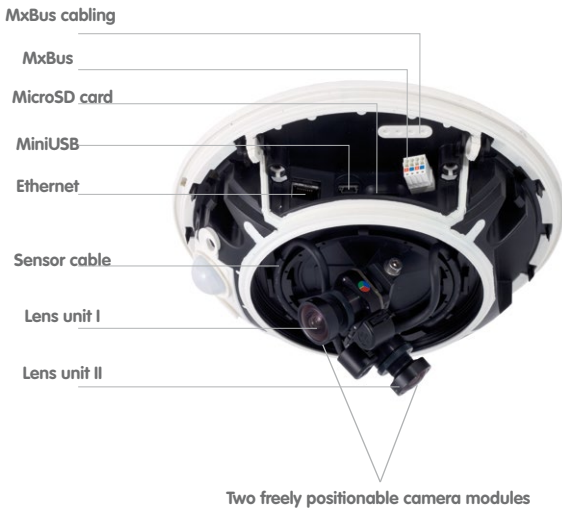

1.3.2 Standard Delivery – D15D-Pano



Item	Number	Part Name
2.1	1	Camera housing
2.2	2	Lens (installed)
2.3	2	Lens mount (installed)
2.4	2	Lock ring (installed)
2.5	2	Sensor cable (integrated, not shown here)
2.6	1	Cable cover (installed)
2.7	2	XL Dome (1x transparent – integrated, 1x tinted)
2.8	1	Outer shell
2.9	1	Ethernet cable
2.10	1	Allen wrench 3 mm
2.11	1	TX20 Torx wrench
2.12	1	Custom tool with magnet
2.13	1	MxBus connector (inserted):
2.14	1	Lens bridge (installed)
2.15	1	MicroSD card, max. of 4 GB (inserted)

Installation accessories

Item	Number	Part Name
M.2.1	3	8-mm screw anchors
M.2.2	3	Stainless steel washers, diam. 5.3 mm
M.2.3	3	Stainless steel wood 4.5 x 60 mm screws with TX20 head

Camera Housing And Connectors – D15D-Pano

The MOBOTIX D15D-Pano consists of three main components (camera housing, outer shell and dome).



- LED default settings:
- 1 Power (on), error (flashes)
 - 2 Recording (flashes)
 - 3 Off
 - 4 Off

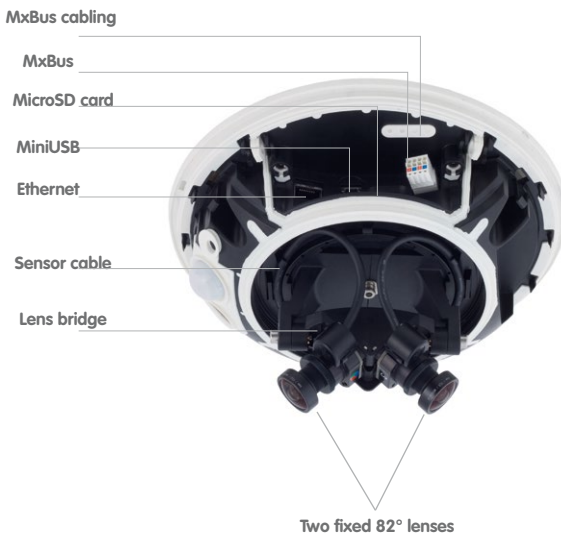

1.3.3 Standard Delivery – D15D-Sec-DNight-Fix

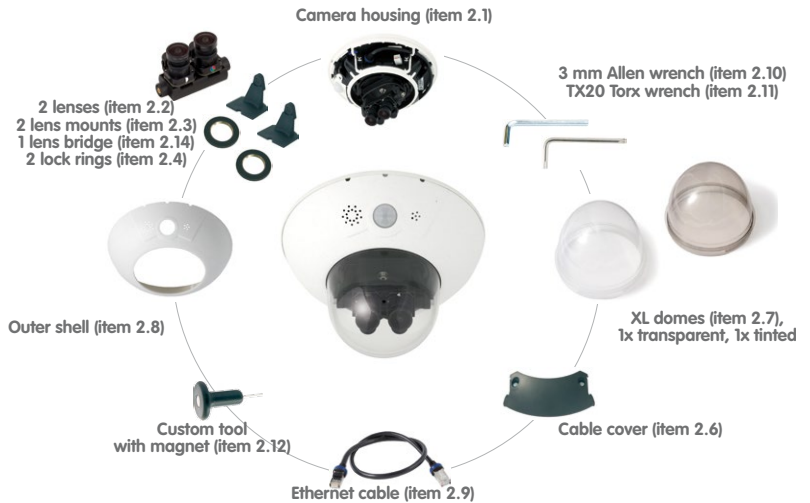

Item	Number	Part Name
2.1	1	Camera housing
2.2	2	Lens (installed)
2.3	2	Lens mount (installed)
2.4	2	Lock ring (installed)
2.5	2	Sensor cable (integrated, not shown here)
2.6	1	Cable cover (installed)
2.7	2	XL Dome (1x transparent – integrated, 1x tinted)
2.8	1	Outer shell
2.9	1	Ethernet cable
2.10	1	Allen wrench 3 mm
2.11	1	TX20 Torx wrench
2.12	1	Custom tool with magnet
2.13	1	MxBus connector (inserted):
2.14	1	Lens bridge (installed)
2.15	1	MicroSD card, max. of 4 GB (inserted)

Installation accessories

Item	Number	Part Name
M.2.1	3	8-mm screw anchors
M.2.2	3	Stainless steel washers, diam. 5.3 mm
M.2.3	3	Stainless steel wood 4.5 x 60 mm screws with TX20 head

Camera Housing And Connectors – D15D-Sec-DNight-Fix

The MOBOTIX D15D-Sec-DNight-Fix consists of three main components (camera housing, body shell and dome).

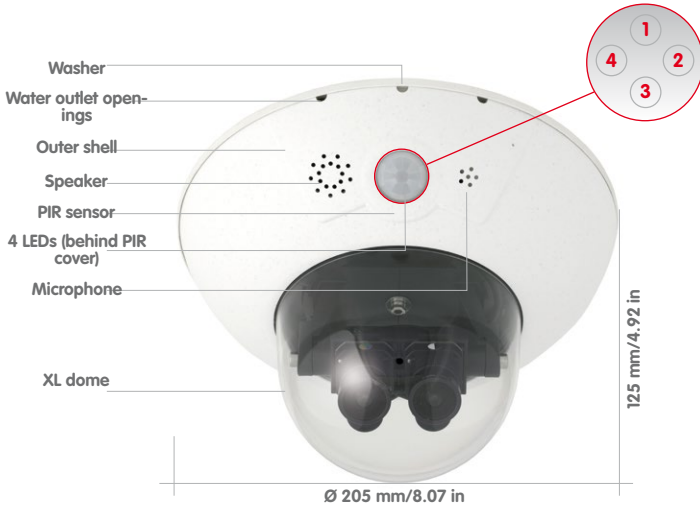

LED default settings:

- 1 Power (on), error (flashes)
- 2 Recording (flashes)
- 3 Off
- 4 Off

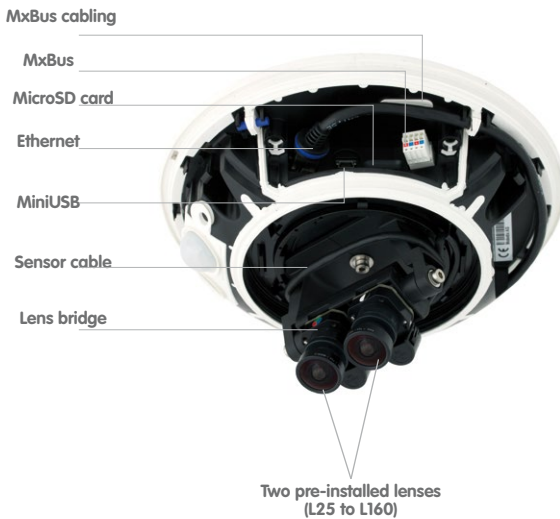

1.3.4 Delivered Parts For The Outdoor Wall Mount (Accessory)

Make sure to check the delivered parts

The original cable supplied with the D15D must be exchanged for a 1-m long Ethernet patch cable to mount the camera with a wall mount

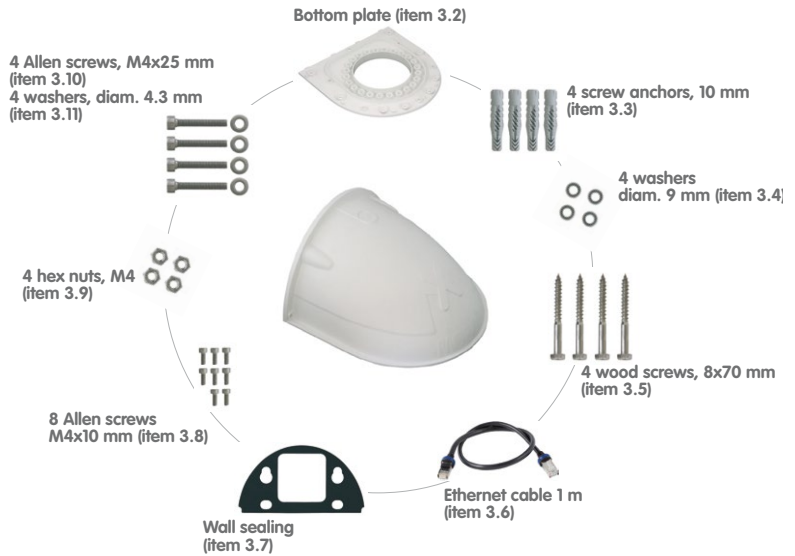

Item	Number	Part Name
3.1	1	Outdoor wall mount
3.2	1	Bottom plate
3.3	4	10-mm screw anchors
3.4	4	Stainless steel washers, diam. 9 mm
3.5	4	Stainless steel wood 8 x 70 mm screws
3.6	1	Ethernet cable 1 m
3.7	1	Wall sealing
3.8	8	Stainless steel Allen screws M4x10 mm
3.9	4	Stainless steel hex nuts M4
3.10	4	Stainless steel Allen screws M4x25 mm
3.11	4	Stainless steel washers, diam. 4.3 mm

The 90 x 90 mm space covers in-wall and on-wall sockets as well as an MX-Patch-Box that is attached to the wall (MX-OPT-Patch1-EXT)

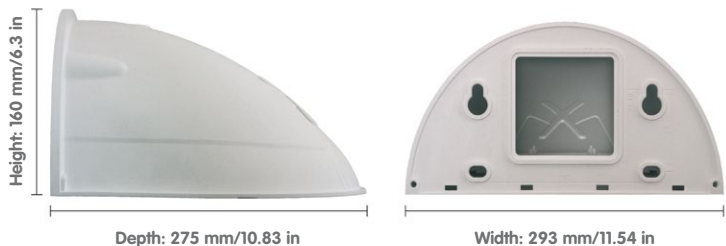

1.3.5 Delivered Parts For The Corner And Pole Mount (Accessory)

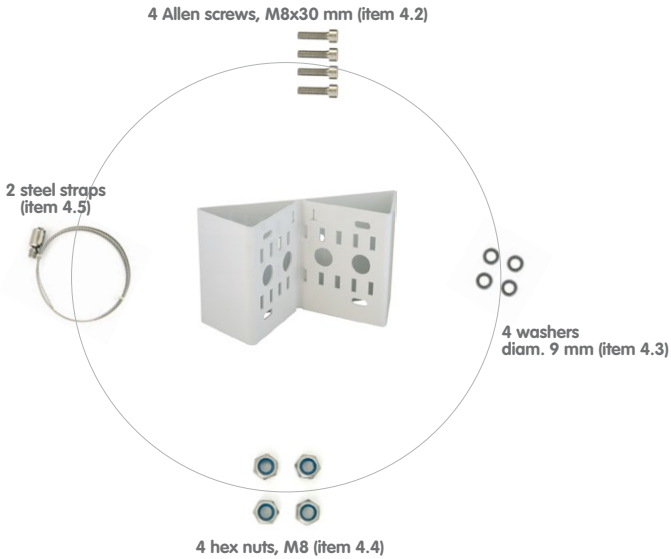

Item	Number	Part Name
4.1	1	Corner and Pole Mount
4.2	4	Stainless steel Allen screws M8x30 mm
4.3	4	Stainless steel washers, diam. 9 mm
4.4	4	Stainless steel lock nuts M8
4.5	2	Stainless steel straps

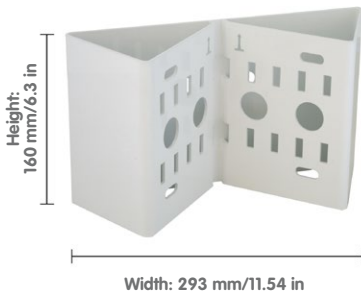

1.4 Available Accessories

1.4.1 NPA-PoE-Set

Order No.: MX-NPA-PoE-EU and MX-NPA-PoE-INT (Version EU and Version INT)

Order No.: MX-CBL-NPA-BAT-2 (battery cable for mobile voltage sources)

This is a multifunctional PoE injector according to the IEEE 802.3af standard – with three connectors (for network, camera/PoE device, PC), universal power supply unit with interchangeable adapter plugs and crossover function. The NPA-PoE-Set connects and remotely supplies a D15D with power via an Ethernet cable up to 100 m in length. The blue adapter can also be connected to mobile voltage sources from 12 V to 42 V by means of an additionally available battery cable. The "EU" version of the NPA-PoE-Set is supplied as standard with a European adapter, while the "INT" version includes four adapters (EU, USA, UK, AUS).



1.4.2 Replacement Dome

Order No.: MX-D15D-OPT-DCT/DCS (transparent/tinted)

The standard D15D dome is available as a transparent version or as a 50 percent-tinted version (also available as an XL dome for D15D-Pano and D15D-Sec-DNight-Fix).



1.4.3 Vandalism Set

Order No.: MX-D15D-Vandal-ESMA/ESPO/PUGR/PUWH/PUBL (matt/polished/gray/white/black)*

Ideally suited for surveillance in extremely harsh conditions. The stainless steel vandalism ring available in five colors replaces the standard outer shell and is securely fastened to the surface using the supplied safety screws. The standard dome is replaced by a polycarbonate dome that has been reinforced and the wall thickness increased to 3 mm.



The vandalism set deletes the PIR and audio features of the camera by design; this can be offset with the ExtIO.

*In D15D models with an XL dome (D15D-Pano and D15D-Sec-DNight-Fix), you can only use the stainless steel vandalism ring and not the reinforced dome

1.4.4 Ethernet Patch Cable With Bayonet Catch

Order No.: MX-OPT-CBL-LAN-1/2/5/10 (length 1 m/2 m/5 m/10 m)

The MOBOTIX-developed special cable can be installed in a waterproof manner and has an integrated sealing gasket. Every D15D ships with a 0.5-m-long cable as standard, which can be exchanged for a patch cable up to 10 m in length.



1.4.5 Outdoor Wall Mount

Order No.: MX-WH-Dome

When combined with the Outdoor Wall Mount, the D15D is fully weatherproof and its protection class is increased from IP54 to IP65 (fully dustproof and resistant to water jets).



1.4.6 Corner and Pole Mount

Order No.: MX-WH-Dome-ESWS

The Outdoor Wall Mount can be used for applications mounted on a pole or the corner of a building. This extremely robust mount is made of 3 mm powder-coated stainless steel (white) and has been designed specifically for outdoor use. The supplied stainless steel straps allow the mount to be attached to poles with diameters between 60 and 180 mm.



1.4.7 MX-Patch-Box

Order No.: MX-OPT-Patch1-EXT

Universal network connector for installation cables, MOBOTIX patch cables and standard patch cables (protection class IP65, -30 to +60°C/-22 to 140°F). The MX-Patch-Box can be used to connect the patch cable of an IP device with the network installation cable (for example, Cat 5) or network patch cable (RJ45 connector) in a weatherproof manner and fits into the 90 x 90 mm space of the Outdoor Wall Mount (see diagram).



1.4.8 MX-NPA-Box

Order No.: MX-OPT-NPA-EXT

The MX-NPA-Box is a weatherproof PoE injector conforming to the IEEE 802.3af standard and is designed to connect to a MOBOTIX camera external voltage source (12 to 57 V DC).

The MX-NPA-Box is equipped with the Patch-Box's weatherproof and extremely compact outer housing (protection class IP65, -30 to $+60^{\circ}\text{C}/-22$ to $+140^{\circ}\text{F}$), which means it can also be installed in the space of the Outdoor Wall Mount. MX-NPA-Box Interfaces: Camera via patch cable, Ethernet via LSA+ and external power supply (12 to 57 V DC is possible)



1.4.9 MX-GPS-Box

Order No.: MX-OPT-GPS1-EXT

This box primarily serves as a high-precision time source for systems without an Internet connection. The IT and Secure models additionally provide triggering of GPS-based events (reaching or moving away from a specified position; exceeding or not reaching a specified speed). The MX-GPS-Box can be connected as an add-on module to all MOBOTIX cameras with an MxBus interface.



The MX-GPS-Box has the same compact exterior housing as the MX-Patch-Box and the MX-NPA-Box (IP65 protection class, -30 to $+60^{\circ}\text{C}/-22$ to $+140^{\circ}\text{F}$). Note that this box should not be installed below other wall-mounted units. It should be installed on the exterior of the building with a large section of open sky above it, which ensures the best possible reception from GPS satellites and thereby the highest possible accuracy of the received GPS data. The maximum length of the MxBus cable (diameter: 0.8 mm) is 50 m.

1.4.10 MX-232-IO-Box

Order No.: MX-OPT-RS1-EXT

This box provides the signal inputs and outputs as well as the RS232 (serial) interface. It replaces the connections that were handled on the older camera models via a D-Sub 15-HD connector. The MX-232-IO-Box can be connected as an add-on module to all MOBOTIX cameras with an MxBus or USB interface. The maximum length of the MxBus cable (diameter: 0.8 mm) is 50 m. If the MiniUSB connection is used, the maximum cable length is 5 m.



1.4.11 ExtIO Expansion Module

Order No.: MX-ExtIO

The device, which is suitable both for on-wall and in-wall installations, contains a powerful speaker, microphone, infrared motion sensor, ambient temperature sensor, two input and two output contacts and two illuminated keys. It is ideal for door communication, elevators, access control systems, etc. The ExtIO is suitable for use as direct connection to the D15D via a MiniUSB cable (max. 5 m), which can be ordered separately, or as a network connection via the PoE switch.



1.4.12 Mx2wire+ Media Converter

Order No.: MX-2wirePlus-Set-PW

The Mx2wire+ system allows an Ethernet network with PoE to be set up via two-wire cables, which saves users from having to lay several hundred meters of Ethernet cable. For example, an existing two-wire cable of an analog video camera can be reused to connect a high-resolution and modern IP network camera. Mx2wire+ is delivered in the standard wall outlet frame in different designs; however, it can also be used with the available on-wall socket that is included.



1.4.13 MiniUSB Cable To MiniUSB (Straight/Straight Or Straight/Angled)

Order No.: MX-CBL-MU-STR-05/2/5 (Straight/Straight)

Order No.: MX-CBL-MU-EN-STR-05/2/5 (Straight/Angled)

With this cable, which is up to five meters long, MOBOTIX add-on modules (MX-232-IO-Box, ExtIO, CamIO) can be connected directly to the D15D.



1.4.14 MiniUSB Cable To USB A Socket

Order No.: MX-CBL-MU-STR-AB-05/2/5

USB-based storage media (for example, USB hard drives) can be connected directly to the D15D with this cable, which is up to five meters long.



1.5 MOBOTIX Software

1.5.1 Integrated Camera Software (Firmware)

MOBOTIX cameras and connected MxBus modules operate with built-in firmware whose functions are accessed by the MOBOTIX **MxControlCenter**, **MxEasy** remote stations and **MOBOTIX App**.

The D15D models therefore also feature a variety of functions that are integrated in the firmware: from motion detection and long-term storage right through to alarm notification via video IP telephony. The virtual PTZ functions allow you to continuously zoom into or out of a MOBOTIX camera image using either the mouse wheel or a joystick.

When recording image or video sequences, you can choose to store either the section of the live image that is visible or the full sensor image (full image storage). This also allows you to examine parts of an image or video that had not been visible in the live image section on display at the time of the recording.

Unlike in the camera systems from other manufacturers, there is no need to buy and install additional software on your computer thanks to the MOBOTIX firmware that can be accessed directly in a web browser via the camera IP address. Instead of using a web browser, you can also download the free **MxControlCenter** or **MxEasy** video management software from the MOBOTIX website (www.mobotix.com > **Support**) to quickly display multiple cameras on one monitor or on an entire video wall, switch alarms with sound or conveniently search for an event. The **MOBOTIX App** for iOS devices (iPhone, iPad, iPad mini, iPod touch, iOS 5.0 and higher) is also available free of charge from the **App Store** for your mobile applications.



Download free of charge
from www.mobotix.com

No licensing fees
Free updates

1.5.2 MxControlCenter

The MxControlCenter video management software can be used to combine any number of cameras at any locations into a well-structured and powerful video security system with centralized or local access-protected operation and analysis.

The state-of-the-art software, specifically tailored to support high-resolution MOBOTIX network cameras, provides a user-friendly user interface and camera image display, convenient video search functions, effective alarm handling, automatic camera integration, video storage on file servers as well as useful configuration and update wizards.

MxControlCenter – Professional Video Management

- Proven worldwide in the most demanding video applications thousands of times over
- Unlimited number of users and cameras
- No license fees
- Individual user interface, adaptable to each individual user
- Simplest installation and complete use on any standard PC
- Convenient layout editor for integrating real building plans
- Integration of conventional network and analog cameras as well
- For Microsoft Windows



Several hundred cameras can be managed on a standard computer

Download free of charge from www.mobotix.com

No licensing fees
Free updates



1.5.3 MxEasy

MxEasy makes it simple to operate the most important functions of the camera thanks to its intuitive user interface and represents a new approach to viewing camera images and controlling MOBOTIX cameras. The clear design allows you to manage up to 16 cameras, and the application can show up to four cameras at the same time.

All settings selected in MxEasy (for example, virtual camera position, zoom, brightness, volume, microphone sensitivity, image storage, signal outputs) can be used immediately and are stored instantly in the configuration of the corresponding camera. The calendar functions integrated in the Alarm Planner provide an innovative tool for the scheduled settings of one or more cameras. This tool not only controls video and sound recording based on certain time and date information, but also allows features like video motion detection, image brightness and the microphone to be activated/deactivated based on a date and time schedule.

MxEasy – Simple Operation Of The Most Important Camera Functions:

- Cameras can be installed without any knowledge of networks
- Supports up to 16 MOBOTIX cameras
- Time- or event-controlled recording
- Time-controlled motion detection, image brightness and microphone
- For Microsoft Windows and Mac OS X

Suitable for up to 16
MOBOTIX cameras

Download free of charge
from www.mobotix.com

No licensing fees
Free updates



1.5.4 MOBOTIX App

Premium solution: There for you whenever and wherever you need it, the MOBOTIX App serves as the perfect remote mobile station that uses intelligent detailed solutions to increase security and convenience for users on a daily basis. The controls are optimized for use with touchscreen devices and feature three main views (Live, Player, Events), self-explanatory symbols, large software buttons, multifunctional sliders developed by MOBOTIX as well as simple gestures like swipe and tap, making it easy for newcomers and older users to work with professional security equipment. In addition, using mobile devices to operate the various functions such as door opening, activating the voice mailbox, switching the door bell off at night and switching a light on/off, creates added value in the form of greater convenience and security in every day life.

MOBOTIX App – Mobile Remote Station For MOBOTIX Cameras And Door Stations

- Bandwidth-optimized remote access via WLAN (WiFi) or the Internet
- Live images and recordings in the best MOBOTIX HiRes quality
- Two-way communication, door opening and video mailbox access
- Doorbell and alarm notifications, protection of privacy
- Convenient search functions, playback of external MxPEG videos
- Grouping of cameras and filtering of events
- Free from the **App Store** for the iPad, iPad mini, iPhone and iPod Touch



Free download from the **App Store**

No licensing fees
Free updates



2 MOUNTING

2.1 Overview Of Mounting Options

2.1.1 Mounting Indoor Cameras To A Ceiling Or Wall (Without Accessories)

In order to mount the MOBOTIX D15D to a ceiling or wall, you need to drill the holes for the fixtures. Use the supplied drilling template (fold-out at the end of this manual) to mark the position for drilling the anchor holes and the holes through which the cables will be led later on. **Remember to position the drilling template according to the direction of the camera's PIR sensor.**

PIR: passive infrared sensor

The folded drilling templates can be found at the end of the manual

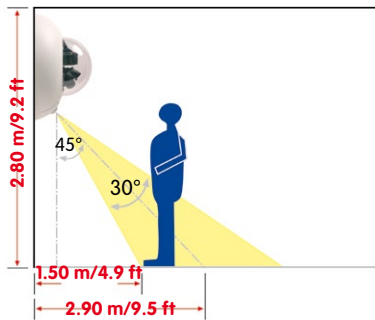

Connecting The Camera Patch Cable To The Network Cable (For Example, Cat 5)

- Position the camera over the cable outlet.
- Connect the camera patch cable securely to the Ethernet cable, for example, using the MOBOTIX MX-Patch-Box.
- Use the correct screws to mount the camera housing to the wall or ceiling.

Preventing Condensation

When installing the camera, make sure that the **PIR sensor is pointing downwards** to allow condensation to flow freely through the openings in the outer shell (see diagram).

The Outdoor Wall Mount may have to be used, as the PIR sensor can be turned in any direction when installed horizontally (PIR is tilted diagonally downwards).



Special Case: D15D-Pano Mounted To A Wall Without The Wall Mount

The lens mount unit has to be rotated by 180° so that you do not get an upside down panorama image. For further information, see the end of *Section 2.3.1, «Mounting Lens Units»*.

Note
Make sure that the camera is always mounted on a smooth surface . Otherwise, the sealing lip on the underside of the housing will not be able to close tightly or will bend upwards, which leads to leaks between the outer shell and the housing.



2.1.2 Outdoor Installation On A Wall, Pole Or Corner (With Accessories)

The associated **Outdoor Wall Mount** can be used to mount the D15D outdoors. The camera is then compliant with the **IP65** protection class (fully dustproof and resistant to water jets). Ambient temperatures may vary between -30 to +60°C/-22 to 140°F, making it the ideal camera for the most demanding weather situations. The drill holes must be prepared for the installation. Use the supplied drilling template to mark the position of the holes for the fixtures and the holes through which the cables will be led later on (fold-out).



If you would like to mount the MOBOTIX D15D to the corner of a building or to a pole, you should consider using the **MOBOTIX Corner And Pole Mount**. This mount can only be used together with the Outdoor Wall Mount. The supplied stainless steel straps allow the mount to be attached to poles with diameters between **60 and 180 mm**.

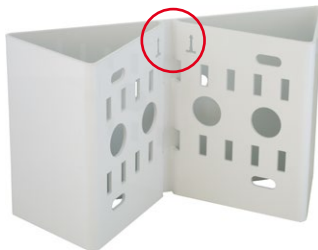

The folded drilling templates can be found at the end of the manual

When printing, make sure that the drilling template is printed in its original size (is neither enlarged nor reduced in size)

Make sure that the arrows are pointing upwards when mounting

The D15D supports the Power-over-Ethernet standard IEEE 802.3af (PoE)

The PoE adapter replaces the crossover cable when directly connecting to a computer

For the D15D, use the blue MX-NPA-PoE-Set - previous MOBOTIX network power accessories such as the NPA-Set, Power-Box and Power-Rack (MX-NPA-Set, MX-NPR-4 and MX-NPR8/20) are not suitable for use with the D15D



2.2 Overview Of Network Connection

2.2.1 Power-Over-Ethernet (PoE Conforming To IEEE 802.3af)

All D15D models are supplied with power using the PoE standard. The PoE Adapter Set (MX-NPA-PoE-Set) may be used for smaller installations. For larger installations, we recommend investing in a PoE-capable supply device available on the market. For detailed information on power supply options and on connecting the D15D camera, please see Section 2.7.1, «Notes On Cable Lengths And Power Supply» and the following sections.



Caution

The **maximum length** of the network cable for power supply over an Ethernet cable is **100 m**.

Previous MOBOTIX network power accessories such as the NPA-Set, Power-Box and Power-Rack (MX-NPA-Set, MX-NPR-4 and MX-NPR8/20) are **not** suitable for use with the D15D.

Note

The MOBOTIX D15D can also be powered by switches or routers that support the PoE (Power-over-Ethernet) standard and conform to IEEE 802.3af.

Advantages of PoE power supply:

- Centralized backup power supply available via network
- Lower, more cost-effective power consumption
- Camera does not require an additional network connection

2.2.2 Uninterruptible Power Supplies (UPS)

In order to maintain a continuous power supply even when utility power fails, you should install an uninterruptible power supply (UPS). These devices also provide full protection against electrical surges and voltage fluctuations and thus enhance the reliability of the system as a whole.

When using a more powerful 19" rack-mounted UPS, you can also protect all other network components (for example, switches, routers, PoE switches, etc.).

Since MOBOTIX cameras do not require any heating, even during winter, the average power consumption of less than five watts is comparatively low. This, in turn, means that you can centralize the UPS-protected power supply by injecting power into the Ethernet cables (max. 100 m). This kind of protected power supply can be used either with MOBOTIX PoE products (MX-NPA-PoE plus Universal Power Supply) or with PoE-compliant switches according to IEEE 802.3af.

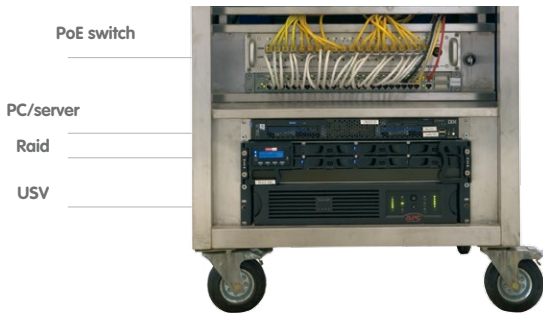

2.2.3 Preparing The Camera Connections, Wall Outlets

Once the camera position, the position of the cable connectors, and the method of power supply have been decided upon, the cabling can be installed. Before mounting the MOBOTIX D15D, you should make sure that the network connections have been properly tested, so that the proper functioning of the camera is guaranteed.

2.2.4 Wiring, Fire Prevention, Lightning And Surge Protection

When installing the wiring inside or outside of buildings, make sure you always adhere to the relevant regulations on wiring, fire prevention, and protection against lightning.

A range of measures are used to protect MOBOTIX cameras against the effects of small electrical surges. These measures, however, cannot prevent the camera from being damaged when stronger electrical surges occur. Particular care should be taken when installing the camera outside to ensure proper **protection against lightning**, as this also protects the building and the entire network infrastructure.

MOBOTIX recommends having its cameras installed only by certified specialists who are used to installing and operating network devices safely and who are familiar with the applicable regulations regarding lightning and fire prevention as well as the current technology for preventing damage from electrical surges.

Wiring

When installing the wiring, make sure to follow these guidelines:

- **Data cable:** Make sure you only use double-shielded Cat 5 or higher cables (**S/STP**) for Ethernet connections.
- **Outdoors:** Installing the camera outdoors requires special precautions and measures regarding the cables as well as lightning and surge protection.
- **Wire lengths:** The cable segments must not exceed the maximum allowed cable lengths in order to ensure proper data transfer.
- **Avoiding induction:** When running data cables parallel to existing regular power lines or high-voltage wires, make sure you observe the minimum distances to the power cables.



Fire Prevention

When installing the power lines to the camera, make sure you always adhere to the country-specific regulations (for example, VDE in Germany, IEEE in the U.S.) in effect on wiring and fire prevention at the site of the installation.

Lightning And Surge Protection

More information on preventing lightning or surge damage is available from organizations such as the International Electrotechnical Commission (www.iec.ch) or from the manufacturers of lightning and surge protectors.



2.3 First Installation Steps





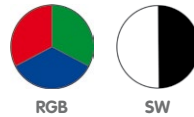

2.3.1 Mounting Lens Units

The standard models in the MOBOTIX D15D series are supplied with a pre-installed dome. Lens units (lens mount, image sensor and lens) are usually delivered separately. Lens units are installed as described below if this is the case.

The sensor cables to connect the image sensors are marked with **R** (right) and **L** (left). Depending on the type of sensor used, the sensors (mounted on the lens units) are marked either by the RGB icon (color) or the SW icon (BW, black & white).



The following combinations of sensor cables (L, R) and sensors (color, black and white) are possible:

Image sensor combination	L sensor cable	R sensor cable
Color/color		
Black & white/color*		
Black & white/black & white		

Possible image sensor combinations for the MOBOTIX D15D (Standard)

*Lenses in DNight versions are shipped pre-installed on the special lens bridge

Note

Make sure that you only use the combinations of image sensors and sensor cables listed in the table!

When setting up the camera, the installed combination of image sensors has to be set in the camera's web-based user interface. You can do so either automatically by running the **Quick Installation (Admin Menu > Quick Installation)** or manually by opening the **Admin Menu > Image Sensor Configuration** dialog box.

1. **Remove the outer shell:** Remove the outer shell using the supplied custom tool. Insert the tip of the custom tool into the three small holes of the shell, one by one. Lift the outer shell to loosen it from the fixtures.



Use the supplied custom tool



2. **Remove the dome:** Pick up the dome using the supplied plastic foil or a cotton cloth and remove it by turning it **counterclockwise**.



3. **Insert the lens units and mount the central lens screw:** Remove the center lock screw and the washer. Insert the lens units into the seatings. Insert the lock screw with a washer into the center of the camera and gently tighten it to hold the lens units in place.



Max. tightening torque of the lock screw: 1 to 1,2 Nm

Note

Touch the mount of the lens units only. Always avoid direct contact with the switches on the green circuit board (ESD) in order to prevent damage arising now or later and to avoid reducing the service life.



4. **Remove the lens cover on the image sensors:** Press the two bars on the side of each lens cover (red arrow) and remove the covers one after another in the direction of the gray arrow.





RGB



SW



5. **Connect the sensor cable to the lens mount:**

Connect the R and L sensor cables with the image sensors in accordance with the table. **Example:** In the case of a D15D-DNight (color/black and white), the **R** sensor cable must always be connected to the lens mount marked with **RGB**, while the **L** sensor cable must always be connected to the lens mount marked **SW**.



Note

Never pull the sensor cable forcefully! To remove it, first disconnect the plug by pressing lightly on the notch (1) and then carefully pull it upwards (2).

Always avoid direct contact with the switches on the green circuit board (ESD) in order to prevent damage arising now or later and to avoid reducing the service life.

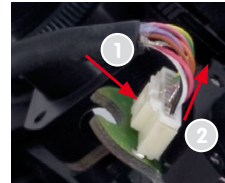

6. **Insert the sensor cable:** Insert the sensor cable through the space in the circuit board. Make sure that the individual wires are gently curved and are not bent near the plug.

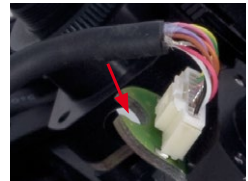

7. **Place the lens cover on the image sensors:** Carefully push the lens covers one after another in the direction of the gray arrow onto the plug until they click into place.



8. **Align the image sensors and cable guide:** Align the image sensors so that the plugs of the sensor cable point towards the interior of the dome (see red marking in the figure). This will ensure the images appear in the correct position later on and not upside down. Make sure that the sensor cable is as straight as possible and fix the cable in place using the corresponding guides.



9. **Mount the dome:** Pick up the dome using the supplied plastic foil or a cotton cloth and screw the transparent dome **in a clockwise direction** onto the housing until the dome sits securely (but not too tightly) in the seal.

Make sure that the dome is not tilted and that it is securely fitted to the seal on all sides.



10. **Attach the outer shell:** Hold the outer shell so that the round hole of the shell is positioned over the PIR sensor of the camera. Gently press the shell into the shell's seats in the camera housing. **Old outer shells (D10D, D12D) may no longer be used!**



If the camera is mounted **on an outdoor ceiling** and is exposed to **extreme conditions**, the three holes in the outer shell should be sealed with commercial silicon in order to prevent water from entering the outer shell.

Special Case: D15D-Pano Mounted To A Wall Without The Wall Mount

The lens mount unit has to be rotated by 180° so that you do not get an upside-down camera image in the vertically mounted camera (PIR sensor points downwards, see *Section 2.1.1*):

- Loosen the two sensor cables from the clamping rails on both sides.
- Remove two Allen screws on both sides of the lens mount.
- Pick up the lens mount and rotate by 180 degrees. Do not tear or jam the cable in the process.
- Reposition and mount the lens mount.

Caution

Due to the associated environmental conditions, the sensor boards may be exposed to a relatively high temperature that is however harmless for camera functioning. Sensor boards should not be directly touched while the camera is running (let them cool down first).

Make sure that the sensor cable is not damaged or disconnected when aiming the lens.



2.3.2 Overview Of Cable Connections

The following cables can be used with the D15D:

- **MOBOTIX Ethernet cable:** This MOBOTIX cable is pre-installed at delivery and is intended for direct connection to a network outlet. If the D15D is to be installed outdoors, the MOBOTIX **MX-Patch-Box** should be used (optional accessory).
- **MOBOTIX USB cable with MiniUSB connector:** This MOBOTIX cable provides the required impermeability, even in adverse weather conditions, and thereby prevents corrosion of the connections.
- **Two-wire cables for MxBus modules:** These cables can be used to connect MOBOTIX modules. The wires of this cable are led along the bottom of the camera and then pushed through the sealing membranes and into the cable guides.



Caution

Only MOBOTIX cables should be used **for the Ethernet and USB connection** to ensure that the cable cover remains permanently sealed.



Ethernet
(network)



MiniUSB

Caution

Appliances with a maximum total power consumption of four watts may be connected to the MxBus connector **and** USB connector **if power is supplied to the camera using PoE class 3**. If **PoE Class 2** is used, **the power consumption of all the connected appliances should not exceed one watt**.

For information on changing the PoE class, see *Section 2.7.5, «Variable PoE»*.

Connection of additional devices with more than 1 W (via MxBus/USB):
Max. ambient temperature +50°C/+122°F

2.3.3 Connecting The Ethernet Cable With The MX-Patch-Box

The **MX-Patch-Box** enables you to connect a MOBOTIX camera with a **patch cable** or with an **Ethernet installation cable** simply and watertightly for the following cases:

- Outdoor installation (preferably using the **Outdoor Wall Mount**)
- Indoor installation with Ethernet installation cable

For more information on the MX-Patch-Box, please visit www.mobotix.com and go to the **Products > Accessories > Interface Boxes** section.



2.3.4 Connecting The MiniUSB Cable

Existing additional modules like the MOBOTIX ExtIO (USB) can be connected via the MiniUSB connector.

Use the supplied custom tool



1. **Remove the outer shell:** Remove the outer shell using the supplied custom tool. Insert the tip of the custom tool into the three small holes of the shell, one by one. Lift the outer shell to loosen it from the fixtures.
2. **Remove cable cover:** Remove the two M4x25 Allen screws from the cable cover using the 3-mm Allen wrench.
3. **Remove cable cover:** Remove the two M4x25 Allen screws from the cable cover using the 3-mm Allen wrench.
4. **Remove rubber plug:** Carefully bend the cable guide upwards and remove the rubber plug. Keep the rubber plug in a safe place (ideally in the camera's original packaging).



5. **Insert USB cable:** Insert the MOBOTIX USB cable from below through the cable outlet (see figure) and wrap it around the camera within the cable guides.



6. **Plug in the USB connector:** Insert the MiniUSB connector in the appropriate socket. Make sure that the cable is correctly fitted into the cable guides and that there is no excess cable in front of the connections.



7. **Place the USB cable in the cable guides:** Carefully bend the cable guides upwards, place the USB cable in the guides and snap the cable guides closed again.



8. **Check the position of the cables:** The two cables should now cross one another just before the connectors.



9. **Install cable cover:** Push the cable cover back into its seat and fasten the two M4x25 Allen screws. When mounting the cable cover, take care to properly align the cover with the seal of the camera housing and the two cable guides. This is the only way to ensure that the connections are reliably protected against any kind of weather.



10. **Secure the cable:** Properly lead the cable through the cable guides at the outer rim of the housing and make sure that the outer shell can be properly mounted later on.



11. **Attach the outer shell:** Hold the outer shell so that the round hole of the shell is positioned over the PIR sensor of the camera. Gently press the shell into the shell's seats in the camera housing. **Old outer shells (D10D, D12D) may no longer be used!**



2.3.5 Connecting MxBus Modules

The MxBus connection of the camera is located under the cable cover and enables additional modules to be operated to extend the functions of the camera. MxBus was optimized specifically for the use of existing two-wire cables.



The white (detachable) MxBus connector has four connections (each of which is blue/red or +/-):

- 2 MxBus inputs to connect the D15D to the MxBus cable
- 2 MxBus outputs to connect an MxBus module to the D15D

You are free to choose the position of the cable for the MxBus connector's inputs and outputs (left or right)

Notes

The MxBus wires that are to be stripped at the end should ideally be inserted into the camera before installation. In the process, every wire (coming from the housing floor) should be pushed through an elastic sealing membrane.

Do not mix up the polarity of the cables during installation. Select a consistent cable color for +/- in the entire MxBus system (for example, red = +, blue = -).



After an MxBus module has been connected, the MxBus itself must be started in the camera's web-based user interface (if this has not been done yet) as well as the actual module (**Admin Menu > Manage Hardware Expansions** or **MxBus Modules**).

2.3.6 Replacing The MicroSD Card

If the supplied 4 GB MicroSD card is to be replaced (for example, with a 64 GB MicroSD card), it is best to do so **before** the camera is installed. **The cards should only be replaced when the camera is disconnected from the power supply.**

Use the supplied custom tool



1. **Remove the outer shell:** Remove the outer shell using the supplied custom tool. Insert the tip of the custom tool into the three small holes of the shell, one by one. Lift the outer shell to loosen it from the fixtures.



2. **Remove cable cover:** Remove the two M4x25 Allen screws from the cable cover using the 3-mm Allen wrench.



3. **Remove cable cover:** If you are unable to do so by hand, press a suitable tool (screwdriver) into the notches provided for this purpose (red arrows). Carefully lift the cover upwards in the direction of the dome.



4. **Remove the MicroSD card:** Carefully press the MicroSD card into the mount until you hear a **click**. The card now protrudes from its seat and can be removed (tweezers may be used to facilitate removal).



Push-push: Push the MicroSD card in, then pull it out



5. **Insert the MicroSD card:** Push the MicroSD card as shown (electrical contacts pointing toward the dome) into the card slot using a tweezers. Make sure that you hear a **click** when the card is inserted. The card is now locked and can be used. **If a new MicroSD card is used, it must be formatted before use** (see Section 3, «Operating The Camera»).



6. **Install cable cover:** Push the cable cover back into its seat and fasten the two M4x25 Allen screws. When mounting the cable cover, take care to properly align the cover with the seal of the camera housing and the two cable guides. This is the only way to ensure that the connections are reliably protected against any kind of weather.



Max. tightening torque of the Allen screws: 1 to 1.2 Nm

7. **Attach the outer shell:** Hold the outer shell so that the round hole of the shell is positioned over the PIR sensor of the camera. Gently press the shell into the shell's seats in the camera housing. **Old outer shells (D10D, D12D) may no longer be used!**



2.4 Mounting The Camera With Outdoor Wall Mount

2.4.1 Aiming The Passive Infrared Sensor (PIR)

When mounting the camera, make sure that the PIR sensor points into the direction where it is most useful. The PIR sensor has a **range of approximately 10 m** and a **detection angle of approximately $\pm 15^\circ$** degrees.

The positions that are available depend on how high the MOBOTIX D15D has been mounted and the alignment of the camera on the **bottom plate**, which can be completed in 15° increments.

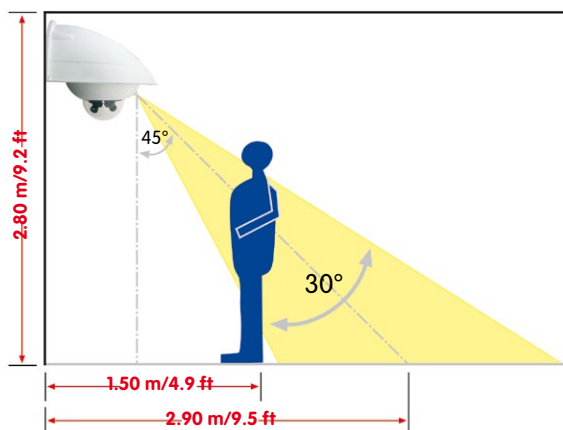

PIR data: range approx.
10 m, field of view $\pm 15^\circ$

Hint: It may be useful to mark the ideal position of the PIR sensor on the bottom plate with a pencil.

2.4.2 Mounting The Outdoor Wall Mount

Ideally, the Outdoor Wall Mount is mounted over the tested wall outlet that provides the connections (network, Power-over-Ethernet) to the camera.

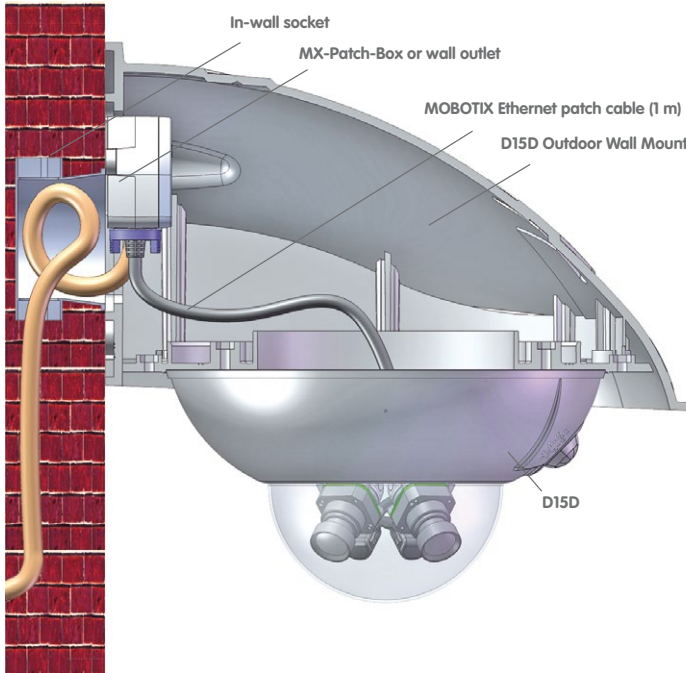

Mounting the Outdoor Wall Mount over the MX-Patch-Box or a socket

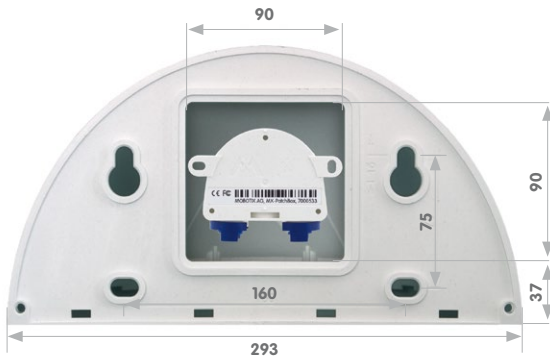

MOBOTIX interface boxes (here: the MX-Patch-Box) also fit in the 90 x 90 mm space

The folded drilling templates can be found at the end of the manual

Make sure that the drilling template is not scaled down when printing

Silicon for rough plaster

Use the **supplied drilling template** (fold-out at the end of this manual) to mark the position for drilling the anchor holes and the holes through which the cables will be led later on. Make sure that it is not scaled down when printing or copying the drilling template.

1. Use the supplied **screw anchors (10 mm)**, **screws (8x70 mm)** and **washers (diam. 9 mm)** to secure the Outdoor Wall Mount.



2. Attach the supplied **wall sealing** to the rear side of the wall mount. If the Outdoor Wall Mount is mounted to a very rough surface, the top of it should be subsequently sealed against the wall using **silicon**.



3. The rectangular opening on the rear of the wall mount is intended to cover the installed in-wall socket or a MOBOTIX interface box.



2.4.3 Aiming The Camera

The camera can be installed once the Outdoor Wall Mount has been mounted to the wall or pole. The bottom plate closes off the outdoor wall mount from below and also holds the camera.

The upper side of the bottom plate has 24 holes for the **M4 stainless steel hex nuts**. It is thus possible to mount the camera in increments of 15 degrees. All holes have been numbered from 1 to 8 in order to facilitate the mounting process.



The bottom plate closes off the Outdoor Wall Mount from below and also holds the camera

Three standard positions to aim the camera are described below:

1. PIR sensor of the camera looks straight **ahead**: Only use the holes numbered with **1** for the **M4 hex nuts**.



PIR looking straight ahead: 1

2. PIR sensor of the camera looks to the **right**: Only use the holes numbered with **3** for the **M4 hex nuts**.



PIR looking to the right: 3

3. PIR sensor of the camera looks to the **left**: Only use the holes numbered with **7** for the **M4 hex nuts**.



PIR looking to the left: 7

2.4.4 Connecting The Camera With Bottom Plate

To mount the camera to the bottom plate, use three of the supplied **M4x25 mm Allen screws**, three **washers (diam. 4.3 mm)** and the corresponding hex nuts.

Caution

When fastening the Allen screws using the 3 mm Allen wrench, make sure that you do not scratch the camera dome!

1. **Exchange the Ethernet patch cable** for the **extension patch cable (1 m)** supplied with the wall mount. Guide the **connection cables of the camera** from below (smooth side) through the round opening of the bottom plate.



2. Position the camera on the underside of the bottom plate so that the PIR sensor points in the desired direction and the hole in the housing to the right of the PIR sensor is situated above a hole in the bottom plate.
3. Insert the **first M4 hex nut** into the corresponding hole of the bottom plate. Then use one **M4x25 Allen screw** and a **washer (diam. 4.3 mm)** and *lightly* fasten the screw.
4. Turn the bottom plate over and identify the number of the hole that has just been screwed in (example: PIR is pointing ahead > Hole has the number **1**). Insert the remaining **M4 hex nuts** into the other holes with the same number (**1**, in this case) and use the two other **M4x25 Allen screws** with the washers to mount the camera to the bottom plate.

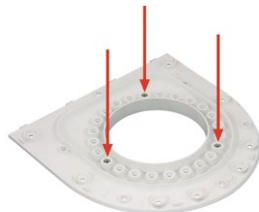

Mount the camera housing to the bottom plate before mounting the bottom plate itself

PIR sensor of the camera looks straight ahead: Position 1

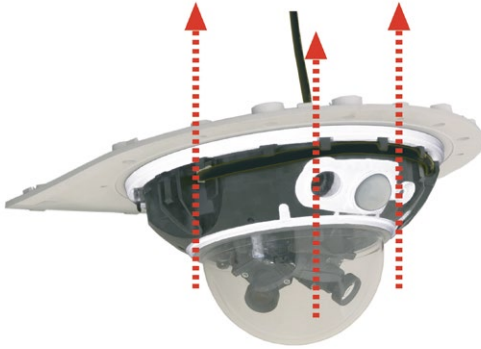

Mounting the camera on the bottom plate

5. **Make sure** that you have properly fastened the three **M4x25 Allen screws**.

2.4.5 Connecting And Securing The Camera

1. Plug the **camera connection cables** into the appropriate wall outlets or adapters.
2. Insert the **(straight) wall side of the bottom plate** into the back of the wall mount as shown in the figure.



Pushing the bottom plate into the Outdoor Wall Mount

3. Push the front of the bottom plate upwards.
4. **Mount** the bottom plate to the wall mount (**eight M4x10 Allen screws**) and make sure the screws are all properly fastened.

Max. torque for all Allen screws: 4 Nm

2.5 Mounting The Corner And Pole Mount

2.5.1 Overview

If you want to mount the MOBOTIX D15D to the corner of a building or to a pole, you should consider using the **MOBOTIX Corner and Pole Mount**. This mount is designed as an additional mounting option for the **Outdoor Wall Mount**. The supplied stainless steel straps allow the mount to be attached to poles with diameters between **60 and 180 mm**.

By design, the Corner and Pole Mount does not allow the use of an in-wall socket for the camera cabling (recommendation: MX-Patch-Box).



Mounted to a corner

Like the Outdoor Wall Mount, the Corner and Pole Mount is made from 3-mm white powder-coated stainless steel and is just as robust and maintenance-free.



Mounted to a pole

2.5.2 Mounting To The Corner Of A Building

Use the **supplied screw anchors, screws and washers** to affix the Corner and Pole Mount to a building corner.

1. Mark the **four screw anchor holes** on the corner of the building. Make sure that the arrows on the mount are pointing upwards. Drill the holes with a 10-mm drill bit.

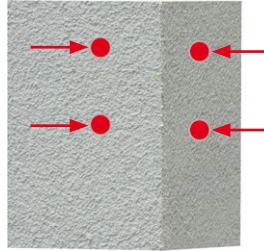

2. Guide the **connection cables** through one of the large round holes at the back of the Corner and Pole Mount and then through one of the two 16-mm holes on the front of the mount. In order to properly **protect the cabling**, you should let the cabling run from the inside of the building through the Corner and Pole Mount directly into the camera. **Note: The cable to the camera should be at least 80 cm from the corner!**



3. Insert the **supplied 10-mm screw anchors** into the screw anchor holes and secure the Corner and Pole Mount to the corner of the building using the **8x70 screws and washers (diam. 9 mm)**.

Attach the **Outdoor Wall Mount to the Corner and Pole Mount** as described in *Section 2.5.4, «Mounting The Outdoor Wall Mount»*.



Make sure that the arrows are pointing upwards when mounting

Make sure not to pinch and damage the cables when mounting

2.5.3 Mounting To A Pole

Use the **stainless steel straps** supplied to affix the Corner and Pole Mount to a pole.

1. Guide the **stainless steel straps** through the holes in the pole mount (see figure). Make sure that you are using the slots of the mount that best fit for the thickness of the pole. The stainless steel straps allow the mount to be attached to **poles with diameters between 60 and 180 mm**.

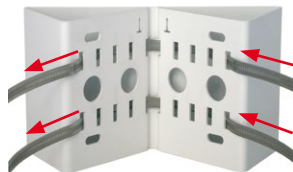

2. Guide the **connection cables** from behind through one of the large round holes of the Corner and Pole Mount. In order to properly **protect the cabling**, you should let the cabling run from the pole through the Corner and Pole Mount directly into the camera. **Note: The cable length from the pole should be at least 80 cm!**



3. **Firmly tighten the screws of the stainless steel straps**. If required, trim the ends of the stainless steel straps.



Pole diameter: 60 to 180 mm

Available soon: Corner and Pole Mount with pre-drilled holes for the MX-Patch-Box



2.5.4 Mounting The Outdoor Wall Mount

Use the **stainless steel screws, washers and hex nuts supplied with the Corner and Pole Mount** to affix the Outdoor Wall Mount to the installed Corner and Pole Mount.

1. Lead the cables through the appropriate hole on the back of the Outdoor Wall Mount.



2. Use the **M8x30 Allen screws, washers (diam. 9 mm) and M8 hex nuts supplied with the Corner and Pole Mount** to attach the Outdoor Wall Mount to the Corner and Pole Mount.



Mount the **camera to the Outdoor Wall Mount** as described in *Section 2.4.3, «Aiming The Camera»* and the following sections.



Lock ring secures lenses against vibrations

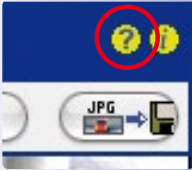

2.6 Adjusting The Lens

Make sure that you see the live image of the camera on the monitor of your computer or laptop. Now adjust the lenses one by one until you see the desired image area on your monitor:

- Remove the **camera dome** using a lint-free cotton cloth.
- Release the **lock ring** of the lens, adjust the **image sharpness** and tighten the lock ring again. **Never turn the lens too far or with force to avoid damaging the lens mount.**
- **Mount the dome again** using a soft cotton cloth.



Notes

The **focusing aid** provides a visual aid when setting the image sharpness of a MOBOTIX camera lens (see the *The Focusing Aid Of The Camera* section on the *The Live View Of The MOBOTIX Camera* page in the camera online help).

Image focus: Due to the lens effect of the dome, the focus of the 135 mm telephoto lens shifts slightly once the dome has been mounted. Before mounting the dome, rotate the telephoto lens by **about 90° in a counterclockwise direction** (against the direction in which the lens is screwed). Make sure that you check the focus of the live image with the dome installed and readjust the lens, if required.



We do not recommend (even) aligning the telephoto lens horizontally due to the image distortions that occur in the top part of the dome for technical reasons.

2.7 Network And Power Connection

2.7.1 Notes On Cable Lengths And Power Supply

- Power may only be supplied to the camera via its Ethernet connector. We recommend using a MOBOTIX PoE adapter or other similar high-quality PoE product to loop-in the power supply:
 - **One camera:** with the PoE adapter (MX-NPA-PoE)
 - **Multiple cameras:** with PoE products conforming to IEEE 802.3af (PoE switch)
- The **maximum length** of the network cable for power supply over an Ethernet cable is **100 m**.
- Make sure that you only use switches or routers that support the **10/100 Mbps Ethernet interface** of the camera. Check the LED activity of the corresponding port at the switch or router.
- We highly recommend using uninterruptible power supplies (UPS) to provide backup power.
- If you are using IEEE 802.3af or IEEE 802.3at ("PoE+") Power-over-Ethernet network components to supply power to your MOBOTIX cameras, make sure, if possible, that these components do not have a fan. As the power consumption of MOBOTIX cameras is very low compared to other products, the reliability of the entire system is increased, thus extending the life of the components.

2.7.2 Power Supply With Power-Over-Ethernet Products

Connect the factory pre-installed cable of the camera to the Ethernet connector of the PoE switch/router. The switch/router must support the **IEEE 802.3af** or **IEEE 802.3at ("PoE+")** PoE standard as a minimum.

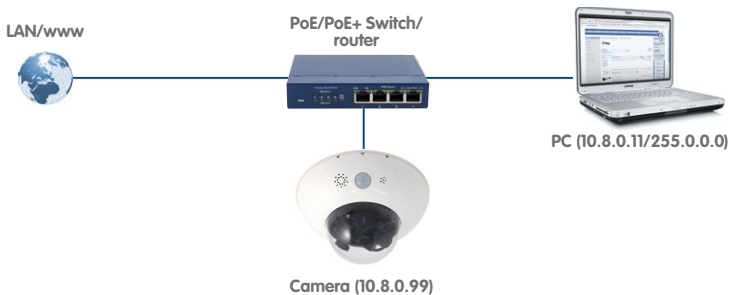

The IP addresses in the diagram are shown only as an example

The IP addresses in the diagram are shown only as an example

For the D15D you should use the blue MX-NPA-PoE-Set or the MX-NPA-Box - previous MOBOTIX network power accessories, such as the NPA-Set, Power-Box and Power-Rack (MX-NPA-Set, MX-NPR-4 and MX-NPR8/20) are not suitable for use with the D15D.



2.7.3 Power Supply Using A Switch

1. Connect the factory pre-installed cable of the camera to the **camera** connector of the PoE adapter.
2. Connect the **LAN/Power** connector of the PoE adapter to the Ethernet connector of the switch/router or the Ethernet socket.
3. Plug the RJ45 connector of the power supply unit into the **PC/Power** connector of the PoE adapter.

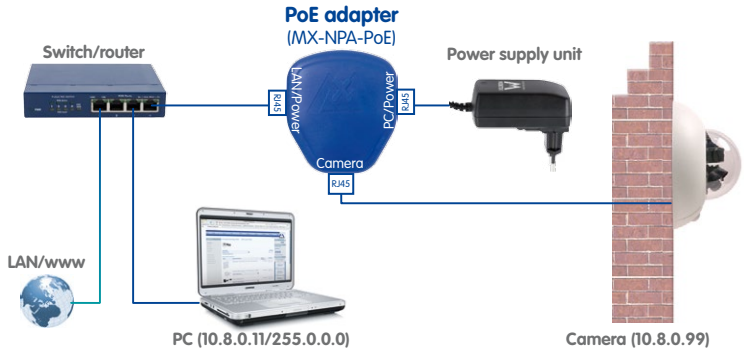

2.7.4 Power Supply When Connected Directly To A Computer

1. Connect the factory pre-installed cable of the camera to the **camera** connector of the PoE adapter.
2. Connect the **PC/Power** connector of the PoE adapter to the Ethernet port of the computer.
3. Plug the RJ45 connector of the power supply unit into the **LAN/Power** connector of the PoE Adapter.



The IP addresses in the diagram are shown only as an example

For the D15D you should use the blue MX-NPA-PoE-Set or the MX-NPA-Box - previous MOBOTIXnetwork power accessories, such as the NPA-Set, Power-Box and Power-Rack (MX-NPA-Set, MX-NPR-4 and MX-NPR8/20) are not suitable for use with the D15D.



2.7.5 Variable PoE

The power consumption of the camera depends on the functions in use as well as any peripheral devices connected (see table). PoE classes 1, 2 or 3 may be selected in the web-based user interface in order to optimally adjust the camera to your system design (PoE switch in use, emergency power concept, etc.).

PoE Power Level Classes (IEEE 802.3af standard)		
Class	Max. power consumption	Camera operating mode and peripheral devices
1	0.44 W–3.84 W	LowPower mode; no peripheral devices (available soon)
2	3.84 W–6.49 W	Normal mode; max. 1 W for MxBus peripheral devices
3	6.49 W–12.95 W	FullPower mode; max. 2.5 W for MxBus peripheral devices (for example, MX-GPS-Box and MX-232-IO-Box to MxBus), max. 4 W for peripheral devices to MxBus and USB interface

Caution

If the total power consumption of the camera and peripheral devices exceeds the power provided by the PoE switch for the specified class, the switch can disconnect the camera from the power supply. ***In this case, the camera will only be accessible again once the peripheral devices have been disconnected from the camera and the camera has been restarted.***

Variable PoE: Multiple cameras can be operated simultaneously from the same switch

The PoE class that has been set is usually fine and nothing needs to be changed. However, if your application requires a lower or a higher power class, you must change this in the browser:

1. Select **Admin Menu > Network Setup > Ethernet Interface**.
2. Click on **Change** under **Power Supply**.
3. A **Power Wizard** will appear to guide you through the PoE configuration steps.
4. Next, restart the camera: Disconnect the camera from the power supply. Then reconnect it, for example, by disconnecting and then reconnecting the Ethernet cable at the PoE switch.

The screenshot shows the 'MOBOTIX Q24 mx10-8x0-113 Ethernet Interface' configuration page. The 'Power Supply' dropdown menu is circled in red, showing 'Power over Ethernet (Class 2)' and a 'Change...' button. Below the main configuration area, a 'Power Supply' section shows a dropdown menu with 'Power over Ethernet (Class 1)' selected. A note on the right states: 'If you are using a PoE switch to power your camera, it may be necessary to select a lower PoE class for the camera so you can use all ports of the switch.'

2.7.6 Camera Startup Sequence

As soon as the power supply has been established, LEDs 2 and 4 will show the progress of the startup sequence:



- **Hardware test:** After the power supply has been connected, LEDs 2 and 4 will light up for about two seconds. The camera's computer checks the camera hardware.
- **Backup system test:** The camera checks the operating system. In case of an error, the camera will start using the backup operating system, allowing you to reinstall the system software.
- **Unpacking the OS:** The camera unpacks the operating system from the flash EPROM and copies it to the camera's memory (LEDs 2 and 4 light up for about ten seconds). Starting the OS: The Linux operating system unpacks its data to the RAM disk and initializes the system.
- **Boot mode (factory IP address/DHCP):** If the magnetic side of the supplied custom tool is pressed to the spot marked L, the camera starts either using its factory default IP address (all LEDs flash) or with DHCP (all LEDs light up). (Please also see *Section 3.2.5* and *Section 3.2.6* in this manual.) The flashing patterns only appear in the case of a hardware reboot, that is, after the power supply has been interrupted.
- **Starting the applications:** Once the application software has started, LED 1 will light up continuously (if it has not been switched off for this configuration). You can now access the camera using your browser.

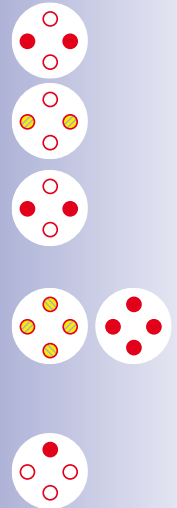

Note

During the startup sequence of the camera, the LEDs will always light up, even if they have been deactivated in **Admin Menu > LED Setup**.

MxEasy and the MxControlCenter control room software are available for free download from www.mobotix.com

Camera software in the browser

3 OPERATING THE CAMERA

3.1 Manual And Automatic Operation – Overview

MOBOTIX cameras do not require any extra software. Thus, you can set up and operate the MOBOTIX camera using a JavaScript-enabled browser on all common operating systems (such as Windows, Linux, Apple, etc.). As an alternative, you can also use the MOBOTIX applications MxControlCenter and MxEasy. Follow these steps to set up the camera:

1. **Connect the camera to the network.** Power is supplied directly via the Ethernet cable (see *Section 2.7, «Network And Power Connection»*).
2. **Set up the camera's network parameters:**
 - **Manually using a web browser** (see *Section 3.2.1*)
 - **Automatically using MxControlCenter/MxEasy** (see *Section 3.2.3* and *Section 3.2.4*) or **via DHCP** (see *Section 3.2.6*)
3. **Configure the camera** using the web-based user interface, MxControlCenter or MxEasy.

Every MOBOTIX camera comes preconfigured with a static IP address in the 10.x.x range (for example, 10.8.0.99). However, local computer networks usually have IP addresses in the 172 or 192 ranges. MOBOTIX cameras must therefore also be given an IP address in this address range to ensure that they can be accessed via the network. You can **set up the network parameters of a MOBOTIX camera** using one of the following methods: **Manually**, using **MxCC** and **MxEasy** or by **DHCP**.



3.1.1 Manually Using A Computer In The 10.x.x.x IP Address Range

You can set up the camera's network parameters using a browser and the embedded camera software. To do so, connect the camera to a computer or network that is using a 10.x.x.x IP address range (see Section 3.2.1, «*Manually Setting Up The Network Parameters In A Browser*»). Afterwards, you can enter the camera's default IP address in the browser's address bar on your computer (see Section 3.2.2, «*First Images And The Most Important Settings In The Browser*»). Next, click on the **Admin Menu** button to open the camera's Quick Installation in the browser's user interface. This is where you can configure the desired network parameters of the camera. Once you have completed the Quick Installation, you can connect the camera with its new network parameters to the desired network.

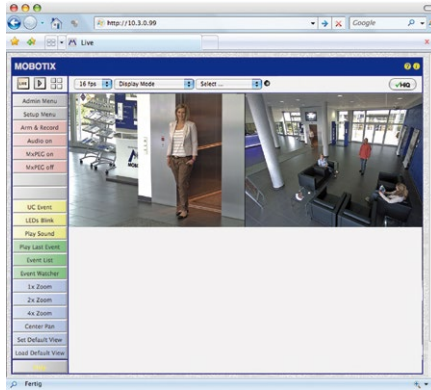

The default IP address of your camera is printed on a sticker on the back of the camera

Benefits

- The camera does not need to be physically accessible, that is, it can remain mounted to a pole, for example.
- No additional software is required.
- The network parameters can be set flexibly through manual entry.

Disadvantages

- The computer or the network needs to operate in the 10.x.x.x IP address range or need to be able to access such a network.
- The setup does not work automatically.
- You need to know the relevant network parameters.

3.1.2 Automatically Using MxControlCenter Or MxEasy

You can set up the camera's network parameters using the free video management software MxControlCenter or MxEasy (see *Section 3.2.3* and *Section 3.2.4*). You can also use one of these applications to automatically configure the network parameters of a MOBOTIX camera that is not operating in the same IP address range as the computer.

MxControlCenter
control room software
(free download from
www.mobotix.com)

MxEasy
(free download
from www.mobotix.com)



Benefits

- You can connect the camera directly to the target network.
- The camera does not need to be physically accessible, that is, it can remain mounted to a pole, for example.
- The camera can be configured to automatically receive an IP address (optional).
- The network parameters can be manually set (optional).
- You do not need to access the camera software.

Requirement

- Either MxControlCenter or MxEasy must be installed on the computer.

3.1.3 Automatically Using DHCP

The camera can automatically obtain its network parameters using DHCP (Dynamic Host Configuration Protocol). This requires the network to have a functioning DHCP server (for example, a DSL router with activated DHCP server) and the camera must be booted using DHCP (see *Section 3.2.6, «Starting The Camera With An Automatic IP Address (DHCP)»*). The IP address automatically assigned by the DHCP server will be announced via the camera speaker as soon as the camera has booted successfully.

Benefits

- You can connect the camera directly to the target network.
- Network parameters are automatically assigned.
- No additional software is required.
- You do not need to access the camera software.

Disadvantages

- The camera needs to be physically accessible as you need to press a key on the camera housing to boot it using DHCP.
- Requires a running DHCP server on the network.



3.2 First Images And The Most Important Settings

Once the MOBOTIX camera has been connected to the network, you need to set up the camera's network interface accordingly. This step involves setting up and checking the network parameters of the camera. If your network is already using an IP address in the 10.x.x.x range with a 255.0.0.0 network mask, you do not need to change the camera's network parameters. You can access the camera directly (see [Section 3.2.2](#)). If your network or computer does not use an IP address in the 10.x.x.x range (for example, in the 192 or 172 ranges), you should follow one of the following methods for changing the camera's network parameters:

- **Manual setup in the browser** ([Section 3.2.1](#))
- **Automatic setup using MxControlCenter or MxEasy** ([Section 3.2.3](#) and [Section 3.2.4](#))

Note

We will use a camera with the factory address 10.8.0.99 in the following examples. Replace this IP address with the IP address of your camera. You will find the IP address of your camera on a small sticker on the camera. Make sure that the IP addresses used in the following examples are not already being used by other devices in the network.

3.2.1 Manually Setting Up The Network Parameters In A Browser

You need a computer that is using a 10.x.x.x IP address in order to manually set up the network parameters of the MOBOTIX camera. The computer's network parameters usually have to be changed for this purpose.

1. Change the network parameters of your computer:

Windows (XP, Vista and 7):

1. Open **Start > Settings > Control Panel > Network Connections**. Clicking **Properties** opens the dialog box shown.
2. Double-click **Internet Protocol (TCP/IP)**. On the **General** tab, activate the *Use the following IP address* option. Enter an IP address in the 10.x.x.x range in this field (for example, 10.8.0.11).
3. Once all dialog boxes have been closed, the computer will have the IP address 10.8.0.11.

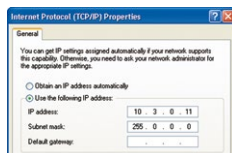
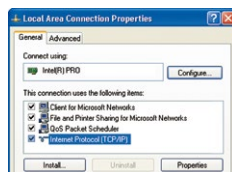

Pressing the "L" key with the magnetic side of the custom tool will prompt the camera to announce its current IP address on the camera speaker (see the figure in [Section 2.7.6](#), «Camera Startup Sequence»)

Entry in "Subnet mask" field:
255.0.0.0

Linux/Unix:

1. Open a terminal as `root` user.
2. Enter the following command: `ifconfig eth0:1 10.8.0.11`
3. The computer is now also using the IP address `10.8.0.11`

Mac OS X:

1. Open **System Properties > Network**.
2. Select **Ethernet**. In the **Configuration** field, select **Manual** and enter a 10.x.x.x IP address (for example, `10.8.0.11`).
3. Click **Apply** on the bottom right-hand side of the dialog box to assign the computer the IP address `10.8.0.11`.

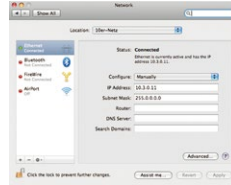

2. Set up the target network parameters of the MOBOTIX camera:

1. Open a web browser on the computer and enter the default IP address of the MOBOTIX camera in the address bar of the browser (for example, `10.8.0.99`). Clicking Enter displays the user interface of the MOBOTIX camera (see also *Section 3.2.2, «First Images And The Most Important Settings In The Browser»*).
2. Click on the **Admin Menu** softbutton in the user interface of the MOBOTIX camera. The Quick Installation starts automatically once the *admin* user has logged on.

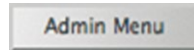

Note: The Quick Installation can also be executed at a later stage by opening **Admin Menu > Network Setup > Quick Installation** (see also *Quick Installation* in the *Camera Software Manual Part 2*).

3. Enter the target network parameters of the camera on the appropriate page of the Quick Installation assistant.

Note: The network parameters can also be modified retrospectively via **Admin Menu > Network Configuration > Quick Installation**.



4. Once you have completed the Quick Installation and rebooted the camera, the new network parameters will be activated. The camera can now be connected to the target network and, if required, further configured.

Default user data

User name: **admin**
password: **meinsm**

3.2.2 First Images And The Most Important Settings In The Browser

Once the MOBOTIX camera has been connected to the power supply and to the network, you can access the user interface with the live camera image in the web browser. Internet Explorer, Firefox, Safari or any other graphical browser with activated JavaScript is suitable. It does not matter which operating system is used.

After entering the camera's IP address in the address bar of the browser, you will see the live view of the MOBOTIX camera with its user interface controls such as softbuttons, buttons for the different camera screens, pull-down menus (Quick Controls), icons for accessing the online help and the camera status and status information elements.

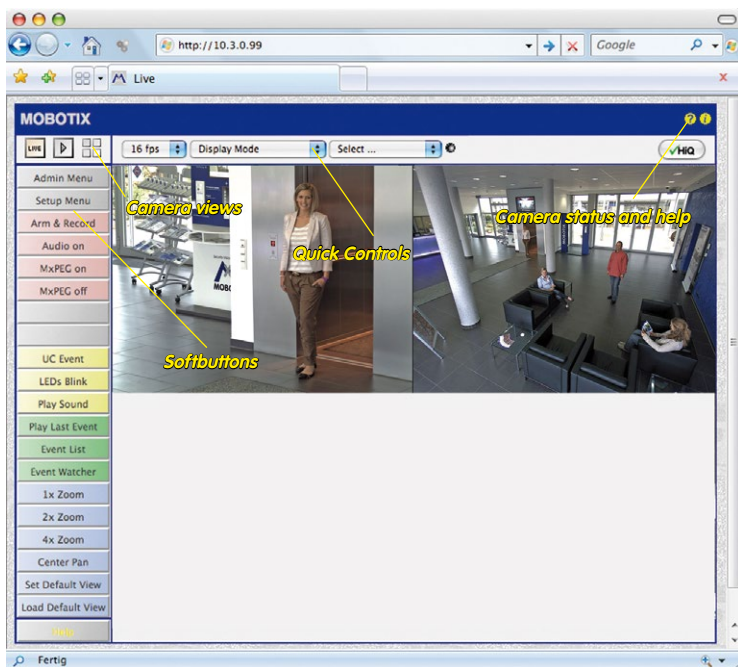

Note

Default access data for the Admin Menu

- Login name: **admin**
- Password: **meinsm**

Camera Views: Live, Player, MultiView

The MOBOTIX camera automatically displays the **Live** screen when it starts up (factory default setting). You can set a different start page in **Admin Menu > Language and Start Page** (for example, the **Guest** screen) to allow a restricted access to the live image.

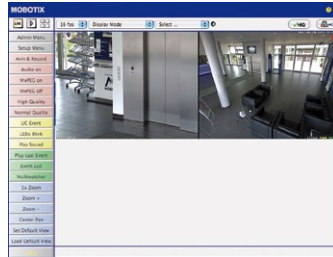

Live view: <http://<camera IP>/control/user-image.html>

The other available standard screens include **Player** (playback of recorded images and video sequences) and the **MultiView** screen (displays several cameras with live or recorded images).

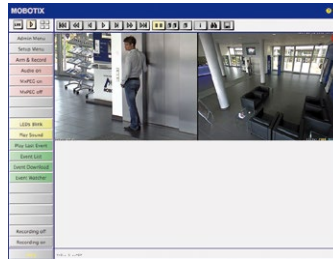

Player screen: <http://<camera IP>/control/player>

MultiView allows you to view several cameras via a "proxy" camera (especially useful if you want to access your cameras from outside of the network with reduced bandwidth) and the **PDA** mode provides a special screen for mobile devices.

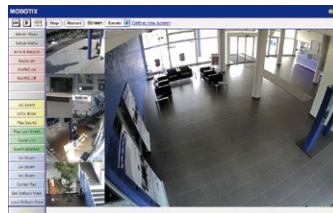

MultiView screen: <http://<camera IP>/control/multiview>

PDA screen: <http://<camera IP>/pda>

PDA event list: <http://<camera IP>/control/player?eventlist&pda>

Guest screen: <http://<camera IP>/cgi-bin/guestimage.html>

Note

Click on the  icon to view further information on the current camera screen in the online help of the camera's user interface.



3.2.3 First Images And Network Parameter Configuration In MxControlCenter

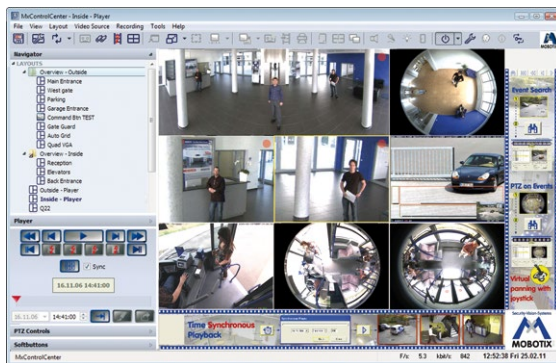

Installation

Download
MxControlCenter
for free from
www.mobotix.com

Download the setup file from the MOBOTIX website to install the latest version. The latest versions are available at www.mobotix.com in the **Support > Software Downloads > MxControlCenter** section.

To install MxControlCenter, simply double-click the setup file and follow the instructions.

The selected files are copied to the computer (older versions will be removed automatically) and the shortcuts are created during the installation process (Desktop, Start Menu, etc.).

Caution

MxControlCenter will automatically attempt to find all MOBOTIX cameras in the physically-connected network (that is, even a MOBOTIX camera with a factory IP address of **10 . x . x . x**). Make sure that the **firewall settings** on your computer are low enough so that MxControlCenter is not blocked. If any MOBOTIX cameras are found, MxControlCenter can **automatically reconfigure** them so that they are available in the current subnet of the computer. If you do not have permission to modify these settings on your computer, contact your system administrator for assistance.

MOBOTIX– Searching And Displaying Cameras

Launch MxControlCenter after successful installation by double-clicking the shortcut that was created by the installer or the executable file `MxCC.exe` in the installation directory on your computer.

The **Add Video Sources** dialog box appears and the application automatically searches for MOBOTIX cameras in the local network when you launch the program for the first time. Select **Video Source > Add** from the menu to perform a camera search at a later time.

If your MOBOTIX camera is properly connected, it should appear together with the existing video sources in the following list:

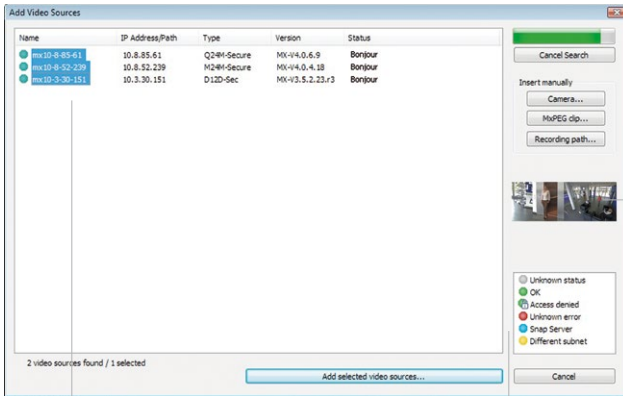

Automated search for MOBOTIX cameras

List of video sources



Legend

Camera preview

Note

Video sources in this context not only refer to cameras, but also to third-party IP cameras, file server paths, videos and analog cameras connected to (for example, analog dome cameras). These video sources are not found automatically and need to be added manually.

Cameras Are Found But Are Located In A Different Subnet

The symbols in the first column and the legend in the dialog box indicate whether you can access a particular camera directly from the MxControlCenter, which is the case for all cameras designated with  (**OK**). Cameras designated with  (**different subnet**) are located in a different subnet. This usually applies to new cameras or cameras that have been reset to their factory settings.

Note

MxControlCenter finds all MOBOTIX cameras, even when the computer and the cameras are not located in the same subnet.

Once you have marked all of the desired video sources in the list with **OK**, you can now select the ones that you wish to display and manage in MxControlCenter. The live image is automatically displayed in the preview window when a camera is selected to help you identify the cameras.

For cameras marked with **Different subnet** or if you want to add additional video sources, follow the instructions in the following sections. You can also display the selected cameras directly in a layout. For more information, see section «*Creating A New Layout*».

Reconfiguring Cameras In A Different Subnet

If one or more MOBOTIX cameras are displayed with the status **Different subnet** (for example, cameras with a factory IP address), MxControlCenter automatically offers to configure the network settings of the cameras. In this case, the application displays the dialog box shown here after you have clicked on the "Add selected video sources" button. Click **Yes** to configure the cameras to the subnet of your computer.

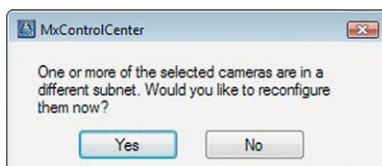

A DHCP server automatically assigns IP addresses for network devices in most networks so that you can automatically select the default setting **Get IP address automatically (DHCP)** in the **Configure selected cameras** dialog box.

Activate the **Use this IP address/this range** option if the IP address of a particular camera must be assigned manually (for networks with static IP addresses). Obtain the assigned IP address, subnet mask and standard gateway from your network administrator and enter the data. All you have to do is enter the range of IP addresses that includes the addresses of all of these cameras to reconfigure multiple cameras at the same time.

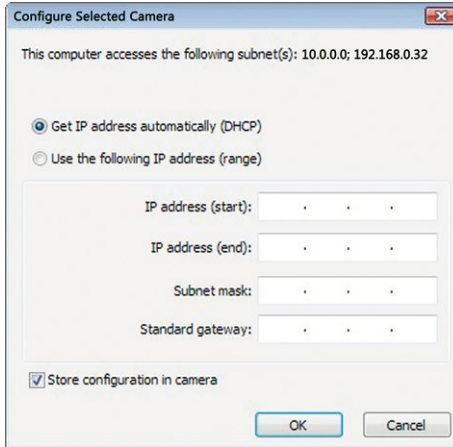

Make sure that the **Store configuration in the camera** checkbox is selected. This setting ensures that the cameras are displayed with the correct network settings even after they have been rebooted. Click **OK** to close the dialog box.

Wait until MxControlCenter has changed the network settings and rebooted the cameras. The status of the reconfigured camera changes from **🟡 (Different subnet)** to **🟢 (OK)**.

Defining Additional Video Sources

In addition to the MOBOTIX cameras that are found automatically, you can also manually add video sources to the list of video sources for MxControlCenter

- **Camera:** Here, you can enter the known IP address or DNS name of a MOBOTIX camera or a third-party IP camera if it was not found by the automatic search feature.
- **MxPEG clip:** Adds an MxPEG video clip previously recorded by a MOBOTIX camera as a video source.
- **Recording path:** Adds the path of an external file server where a MOBOTIX camera has recorded audio/video data. The videos or images recorded at that location can now be played back using the **Player** or **Video Search**.

Editing The Video Source List

Right-click this list to open a shortcut menu from which you can select all video sources or cancel the selection. You can also use this method to remove from the list some or all of the video sources that you do not want to display or manage in MxControlCenter.

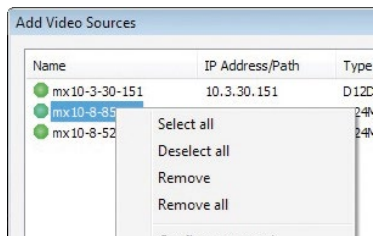

If you have cancelled the camera configuration process or need a password that differs from the camera's factory default password, you can also configure the camera from the shortcut menu at a later date and enter the user name and password required for reconfiguration at that time.

It is also possible to open the **Configure selected cameras** dialog box using the shortcut menu in order to change the camera network parameters.

Creating A New Layout

Select the camera or other video sources that you would like to display in a layout (a view with a group of selected cameras) in the **Add video sources** dialog box and then click **Add selected video sources**.

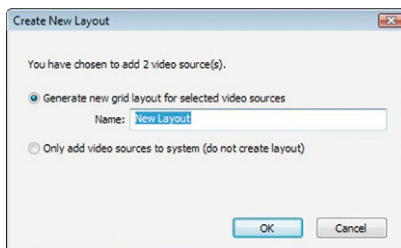

The **Create new layout** dialog box is displayed. If you select the **Generate new grid for selected video sources** option here, MxControlCenter automatically generates a grid layout that displays windows of the same size for all selected video sources. Give each layout a unique name (for example, **Underground garage**).

If you select the second option, the video sources you selected are simply integrated in the MxCC system where you can use them to generate a layout at a later time.

Click **OK** to confirm your selection.



Download MxEasy for free from www.mobotix.com

3.2.4 First Images And Network Parameter Configuration In MxEasy

Installing And Starting MxEasy

Download the current version of MxEasy from the MOBOTIX website (www.mobotix.com) > **Support** > **Software Downloads** in the **MxEasy** area). Double-click the shortcut for the program or the program file.

Finding Cameras

When you start MxEasy for the first time on a computer, the MxEasy Wizard automatically begins to search for MOBOTIX cameras and displays all the cameras found in a list. The camera list will be updated automatically as soon as new MOBOTIX cameras are connected to the local network or removed from the network.

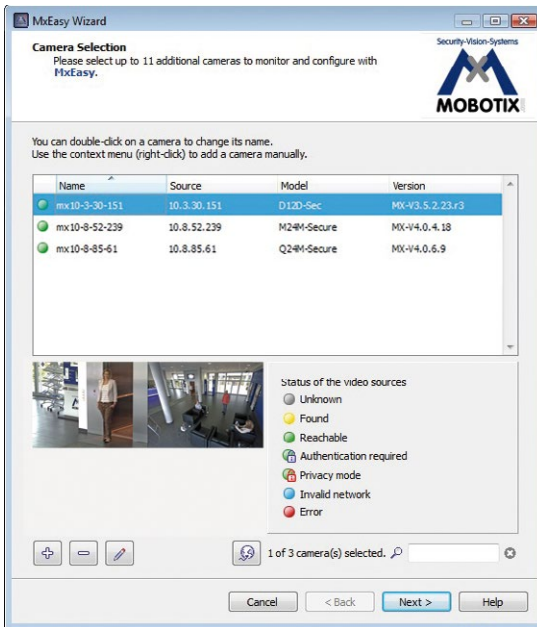

MxEasy also automatically monitors and displays the operating status of all cameras. Cameras that are not on the same subnet as the computer will get a differently colored symbol than the cameras that are on the same subnet. Likewise, the cameras that have an unknown password or for which no user name/password combination has been specified in MxEasy will be displayed in a different color. The following section contains information for cameras with the status **Invalid network** (for example, for all new MOBOTIX cameras with factory settings) and includes tips for configuring the cameras for the "right" subnet.

*Bonjour: automatic recognition of network services in IP networks

Reconfiguring Network Addresses Of Cameras

Using Bonjour*, MxEasy not only finds cameras on the same network as your computer, it also finds MOBOTIX cameras located in other subnets (status **Invalid network**). In such a case, you would not be able to establish any connection to cameras in a different network or subnet (without going into much further detail regarding TCP/IP network configurations). This is possible, for example, when a camera with a factory IP address is connected to a network in which a DHCP server automatically assigns the IP addresses. MxEasy can automatically configure such a camera so that it is "integrated" into your existing network. To do so, you only have to select the affected camera in the list and then click **Continue**.

After a security prompt, a new dialog box for configuring the selected camera is displayed.

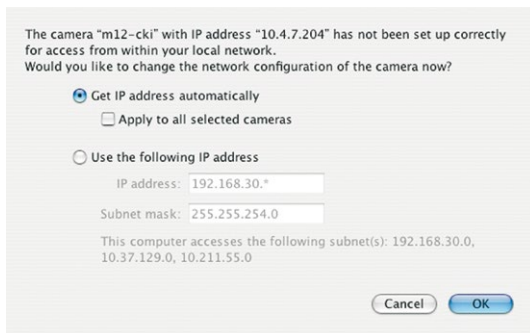

The camera "m12 - cki" with IP address "10.4.7.204" has not been set up correctly for access from within your local network.
Would you like to change the network configuration of the camera now?

Get IP address automatically
 Apply to all selected cameras

Use the following IP address

IP address: 192.168.30.*
Subnet mask: 255.255.254.0

This computer accesses the following subnet(s): 192.168.30.0, 10.37.129.0, 10.211.55.0

Cancel OK

If your computer automatically obtains its IP address from a DHCP server, then this is certainly the best choice for that specific camera and most likely for all other cameras that have been found in a different subnet (**Get IP address automatically** option).

If you have assigned a static IP address to your computer, you will probably want to assign static IP addresses (issued by your system administrator) to every camera (the **Use this IP address** option). Normally, you enter the same configuration used for the network settings of your computer.

When you click **OK**, the selected cameras are automatically reconfigured and they are located in the same subnet as the computer.

Integrating And Displaying Cameras

After a camera has been reconfigured, it has the status **Accessible** and can be integrated into MxEasy. The MxEasy Assistant then displays the **Define integration mode in MxEasy** dialog box.

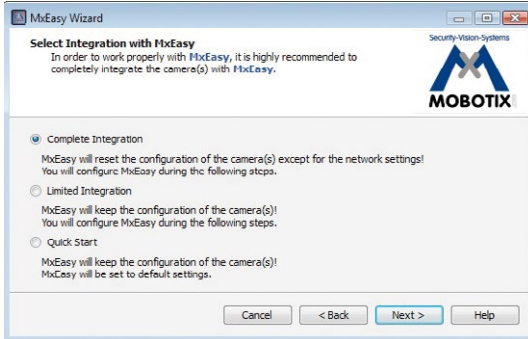

Here, you can jump directly to the main window of MxEasy with the current live camera image by activating the option **Quick Start**. However, some required detailed configurations may have to be made at a later time (for example, password protection, available bandwidth). For this reason, we recommend activating the option **Complete integration** and complete the remaining dialog boxes of the MxEasy Assistant until the main window appears.

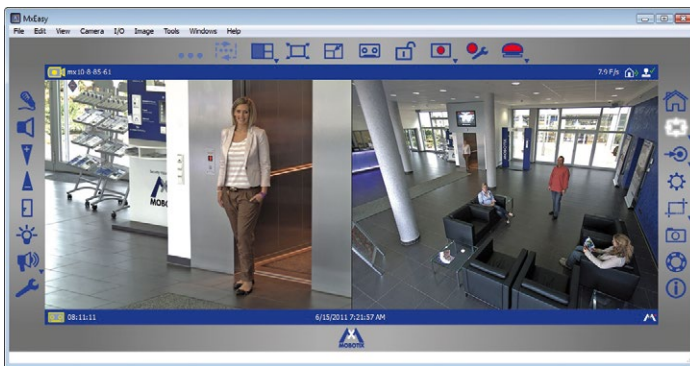

Main window with dual image display of a D15D (telephoto lens and wide angle)

For more information, see the **MxEasy User Manual**, which can be downloaded as a PDF file from the MOBOTIX website: www.mobotix.com > **Support** > **Manuals**.

Passwords and camera settings will not be changed

3.2.5 Starting The Camera With The Factory IP Address

Under certain circumstances, you may have to reset the camera to its factory IP address. This could be the case, for example, if the IP address has been lost or the camera does not respond to the last known IP address.

1. If the camera is powered on, disconnect the power supply by unplugging the corresponding cables and then reconnect the power supply.
2. After about ten seconds, the LEDs will light up and blink for about four seconds.
3. **After they stop blinking (all LEDs light up continuously now), hold the magnetic side of the custom tool over the spot above the microphone labeled L in the figure** (the switch is inside the camera housing).
4. If you skip this step, disconnect the camera from the power supply and start from the beginning.
5. **Release the custom tool after around 40 seconds** when the camera emits a single sound ("boing").



Notes

If you use the camera's **L key** to load the factory network configuration, this configuration is not automatically saved in the camera's flash memory. When the camera is next rebooted without using the **L key**, the last stored network configuration will be used. To permanently store the new network configuration in the camera's flash memory, open **Admin Menu > Store**.

As opposed to resetting the camera using **Admin Menu > Reset configuration to factory defaults**, the user information will not be reset if the camera is booted using the factory IP address.

Make sure you store the default network configuration to the permanent flash memory

Users and passwords will **not** be reset!

3.2.6 Starting The Camera With An Automatic IP Address (DHCP)

If your network has a DHCP server, you can start the MOBOTIX camera with DHCP support. The camera automatically obtains an IP address from the DHCP server and announces the new network data. Note that if the speaker has been previously deactivated, the announcement will not be audible (**Admin Menu > Microphone and Speaker**).

1. If the camera is powered on, disconnect the power supply by unplugging the corresponding cables and then reconnect the power supply.
2. After about ten seconds, the LEDs will light up and blink for about four seconds (first blink), light up continuously and then blink again for about four seconds (second blink).
3. **After they stop blinking for the second time (all LEDs light up continuously again), hold the magnetic side of the custom tool over the spot above the microphone labeled L in the figure** (the switch is inside the camera housing).
4. If you skip this step, disconnect the camera from the power supply and start from the beginning.
5. **Release the custom tool after around 25 seconds** when the camera emits a sound twice ("**boing, boing**"). The network data is announced shortly afterwards.



Notes

Starting the camera with an automatic IP address (DHCP) is only **temporary**. The network configuration of the camera can be permanently set to DHCP under **Admin Menu > Ethernet Interface**.

Make sure that the network has a functioning DHCP server when starting the camera with DHCP support. If this is not the case, the camera cannot obtain a valid IP address and will use its last IP address.

You should also make sure that the cameras always obtain the same IP addresses by assigning the MAC addresses of the cameras to the desired IP addresses.

In case of an error, the camera uses its last IP address

3.3 Virtual PTZ And Full Image Recording

3.3.1 Virtual PTZ

The virtual PTZ function allows you to use a mouse or joystick to continuously zoom in on images from the selected video source and "virtually" move the enlarged image section within the entire image sensor area.



USB joystick offers greater ease of use

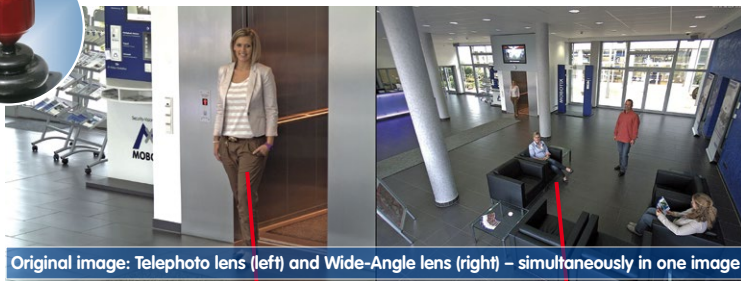

Original image: Telephoto lens (left) and Wide-Angle lens (right) – simultaneously in one image

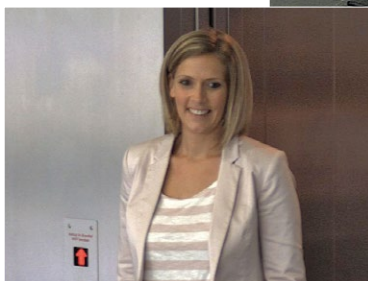

Operation Using The Mouse And Scroll Wheel

The vPTZ function of the D15D can be controlled in the browser using the mouse. This position becomes the new image center by clicking any position on the image displayed on the monitor. The image moves accordingly and the image distortion is automatically corrected. The **scroll wheel** can be used to control the zoom function. This functionality is disabled in the default settings of the camera and must therefore first be activated. To do so, go to **Setup Menu > vPTZ Settings**, disable **Lock Mouse Wheel Zoom**, click **Set** and then **Close** to save your settings. You can now use the scroll wheel to zoom + (scroll forwards) or zoom - (scroll backwards).

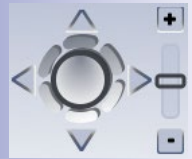

Operation Using USB Joystick

A standard USB joystick can drastically improve vPTZ operation for the user – in the browser, in MxEasy, and in the MxControlCenter (however, MxCC is also equipped with a virtual joystick that can be operated using the mouse). Please first install the joystick on the computer according to the manufacturer's instructions.

In order to use a USB joystick in the browser, make sure that you have a computer running a Windows operating system and the latest version of Internet Explorer and that the **"ActiveX" mode in the camera software (browser) is activated:**

- Switch to **Browser** in the Quick Control.
- Under **Browser**, select the option **ActiveX** in the field to the right. The USB joystick can then be used until the browser is closed.
- To store the setting permanently, ActiveX must be activated in the **Admin Menu**. To do so, use **Language and Start Page** in the Admin Menu.
- Under the page options, select the **ActiveX** operating mode.
- Store the settings permanently in the camera by clicking **Set** and **Close**.
- The joystick can now be used.

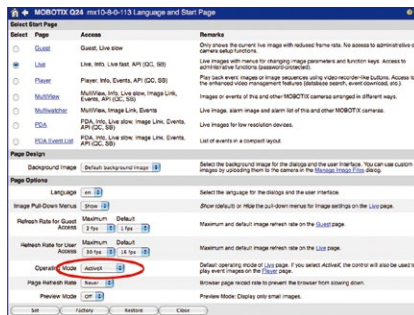
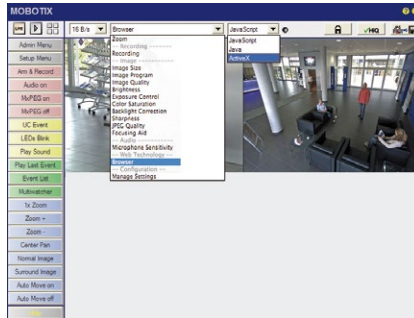

Notes

You will find more information and details on vPTZ in the **Camera Software Manual Part 2** in *Section 4.3.6 "Virtual PTZ"*, the **MxEasy** manual in *Section 2.4.1 "Activating The PTZ Features"* and the **MxControlCenter** manual in *Section 2.4.6 "Using The vPTZ Features"* and *Section 3.1.4 "PTZ Controls In The Sidebar Panel"*.

The latest versions of all the manuals are available for download from the MOBOTIX website www.mobotix.com under **Support > Manuals**.

3.3.2 Full Image Recording

It is possible to record a **full image**, regardless of the live image stream that is being displayed. This ensures that the recording always contains the full image of the lens used, even though the operator may have used the vPTZ features to zoom into the image in order to examine a specific detail.

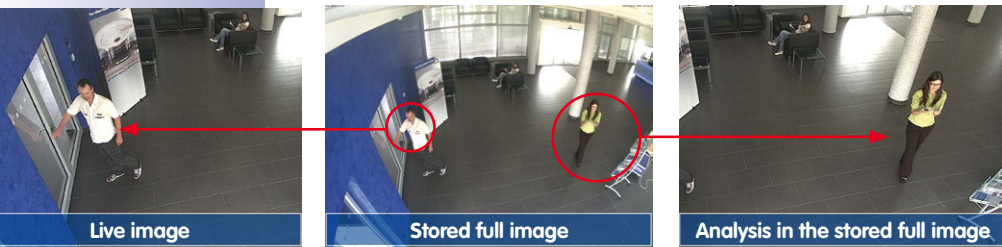

Stored full image:
Original camera image
without distortion or
image correction

This means that you can use the vPTZ features in VGA resolution to pan, tilt and zoom in the live image while the camera is, for example, recording full images at 1 fps in MEGA or QXGA resolution.

In **MxEasy** and **MxControlCenter**, the recorded full images may be prepared for the user with the vPTZ functions (for example, panning and zooming in on an image detail such as a doorway).

If **full image recording is not activated**, only the last displayed live image will be saved (save what is seen). The **main benefit** of live image storage is to ensure that the full power of the camera processor is used for live image correction and maximum frame rates. The **main advantage of full image recording** lies in the special functionality of the D15D, in that it can always maintain availability of a maximum size (full) image for later investigation, despite vPTZ actions carried out on the live image. The mechanical limitations of motor-driven PTZ cameras mean that they simply **cannot** provide this unique advantage to the user!

Notes

Post-event search in the full image: If you are using full image recording on D15D cameras, you should use at least MEGA resolution when storing. This will facilitate later searches in **MxControlCenter** or **MxEasy**. The advanced distortion correction features require this function to deliver satisfactory image quality.

Full image recording on: Due to the increased processing time, full image recording reduces the data rate of the live image stream, which may drop by around 10 to 30 percent. We therefore recommend reducing the frame rate for storage as much as possible to affect the live image stream as little as possible.

Full image recording off: The event that triggered a video motion (VideoMotion VM) window may not be in the recorded sequences while the window was not displayed at the time.

Activate/Deactivate Full Image Recording In The Browser

To configure this feature, open the **Setup Menu > Event Control > Recording** dialog box and activate or deactivate the **Full Image Recording** option.

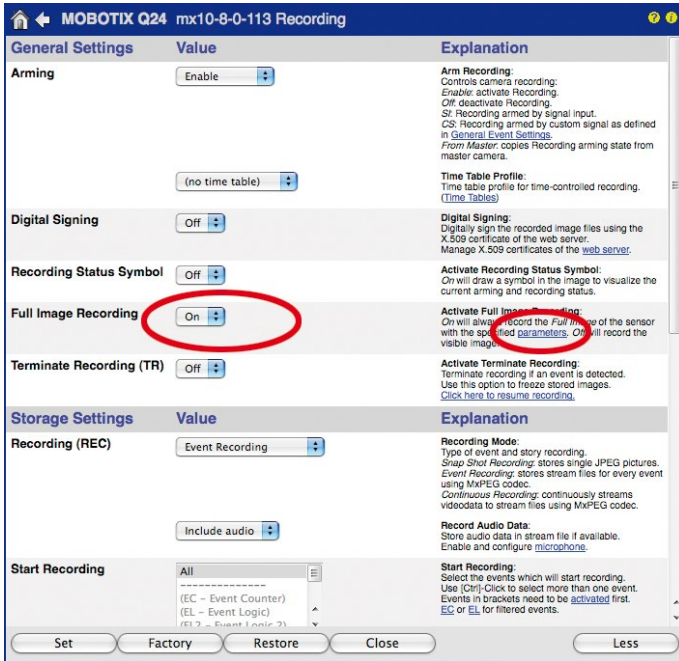

3.4 Image Optimization

3.4.1 Correction Of Lens Distortion (L25 Only)

If you are using a camera with the **82° Wide-Angle Lens**, the image, particularly around the edges, may be slightly distorted due to the extreme angle of the lens.



You can suppress this effect using software (for example, in the browser) so that a new and appropriately corrected image can be displayed live. A side effect of this correction, however, is that a cushion shape appears around the edges of the image.

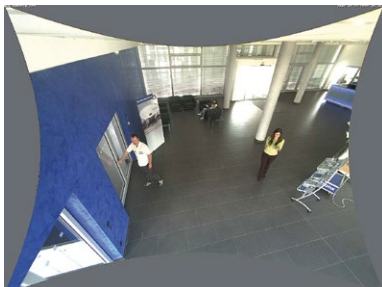

To hide this cushion effect, you simply have to **Zoom In** on the image slightly. Although this reduces the size of the captured area, the image is almost distortion-free compared to the original.

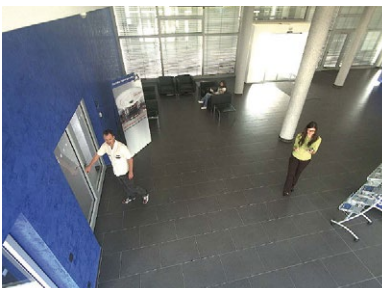

Since activated lens distortion correction requires additional processing power, you should consider disabling it in situations where it is not really necessary. You will only notice a minimal distortion of the image, especially if you use the zoom. However, the maximum frame rate for high resolution may be reduced (by 10 to 25 percent), which means you have to choose between maximum distortion correction or maximum frame rate.

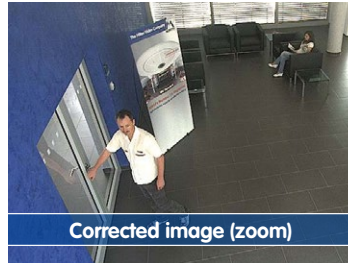
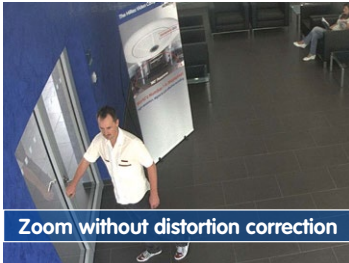

We recommend activating lens distortion correction, especially for applications with a low frame rate and non-zoomed images (for example, when using as a webcam). However, images can usually be corrected at a later point in time when searching recorded images. This saves on processing power during recording and increases the frame rate. The more you zoom in on the image, the less distorted the image should appear.

Activate/Deactivate Lens Distortion Correction In The Browser

To activate this option, first specify the lens that you are using in the **Admin Menu > Hardware Configuration > Lens Configuration** dialog box (this setting is saved until the camera is reset to its factory settings). Select the **L25 (4.0 mm)** option from the **Lens Type Selection** field, then click on **Apply** and **Reboot** the camera.

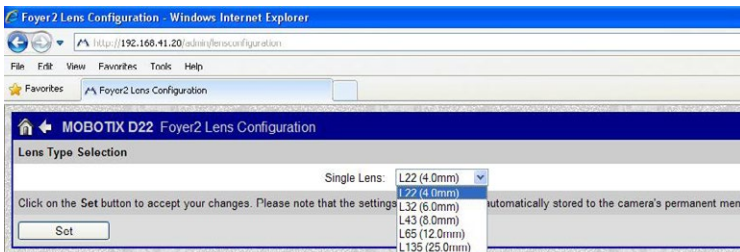

Now select the **Lens Distortion Correction** option in the **Display Mode** Quick Control panel. An automatically corrected (live) image is displayed that can be panned, tilted, or zoomed. Switching to the **Full Image** option will deactivate the automatic distortion correction function.

3.4.2 Adjusting The Panorama Image (D15D-Pano Only)

The D15D-Pano with integrated panorama function has two 82° Wide-Angle lenses that are mounted on a lens bridge in such a way that they produce a panorama image. The two individual images do not always fit together completely and seamlessly because of the mounting position of the individual cameras and the lens adjustment.

Note

Make sure that the camera is not tilted too far down to ensure that you get a good panorama image. The image area that is most interesting for the viewer should be in the center of the image so that the camera creates an image that is as close to reality as possible.

Adjusting The Panorama Image In The Web Browser

You need to follow these extra steps when installing a D15D-Pano to create a good combined image from the two single images (left and right image sensor).

Step 1: Activate the configuration for the panorama view

Open the user interface of the camera in the browser. Click on the **Configuration For The Panorama View** Quick Control above the live image and set the value in the field to the right to **Activate**.

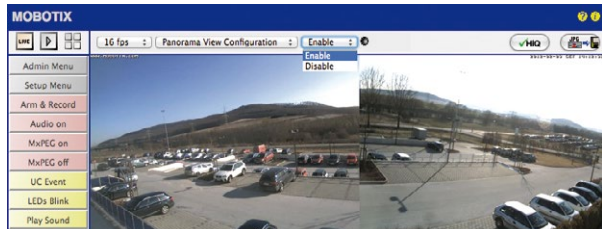

Step 2: Image adjustment using the OnScreen control

As soon as you click the live image of the camera, an OnScreen Control appears in the top left corner of the live camera image. Using these elements, you can adjust the two individual sensor images to form the desired panorama image. This requires a resolution of at least VGA. If your currently set resolution is less than VGA, the camera automatically switches to VGA mode to carry out the adjustment and it returns to the original resolution after the OnScreen Control is hidden again.

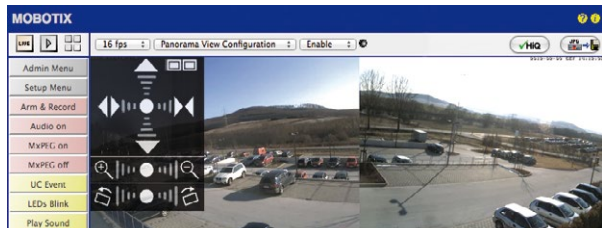

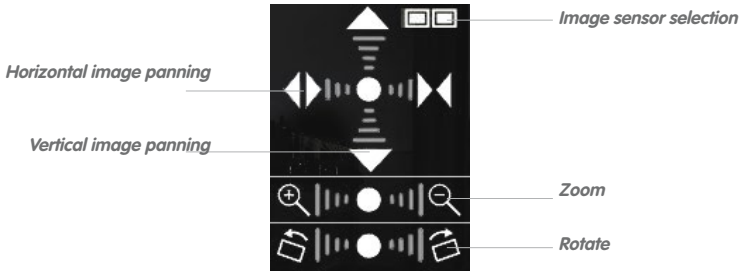

Using The OnScreen Control:



Clicking the central point of the dial resets the image to the corresponding factory default settings

Select image sensor: The two rectangular checkboxes in the top right corner display which sensor image is currently selected and can be configured. You can change the selection by repeatedly clicking the checkbox symbol:

- Both sensor images selected 
- Only left sensor image selected 
- Only right sensor image selected 

Zoom in on image(s): You can change the zoom factor by clicking the respective magnifying glass symbol in the range. The effect is greater the further you click from the center of the range. You should be able to zoom until, on the one hand, the cushion-shaped borders caused by the distortion correction disappear (ZOOM +) and on the other hand, the objects in the vertical center of the image are visible (ZOOM -).

Move image(s) vertically: You can move the selected sensor image up or down by clicking on the arrows pointing upwards and downwards in the range. The effect is greater the further you click from the center of the range.

Move image(s) horizontally: You can move the selected sensor image to the left or right by clicking the arrows pointing left and right in the range. If both sensor images are selected simultaneously, they can be moved away from one another by clicking the left side of the range and towards one another by clicking the right side of the range.

Rotate image(s): You can rotate the sensor images to the left or right individually or together synchronously by clicking the edges of the rectangles on the bottom of the range. This way, you can correct any offset in the lens mounts.

Step 3: Save the settings and exit the function

When you have finished adjusting the image, set the value field to the right of the **Configuration Of Panorama View Quick Control** to **deactivated**.



This opens a dialog box. Confirm by clicking **Yes** to save the current settings and then switch back to the live image of the camera.

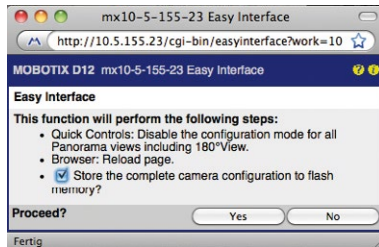

To adjust the images again in the future, you must switch back to **Configuration of Panorama View** in the Quick Control and set the value field to the right to **activated**. The OnScreen Control opens and you can proceed as described starting with Step 2.



Adjusting The Panorama Image In MxEasy

You can also use MxEasy to configure the panorama view of a D15D-Pano. Select the **Image** menu item from the **Image Formats and Views** option in the menu bar at the top of the screen. Then click **Compass** in the toolbar.

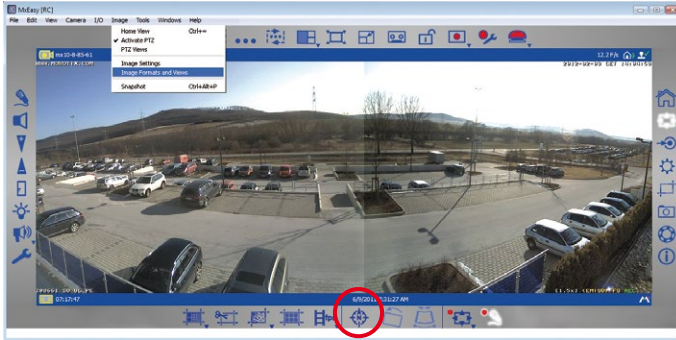

An OnScreen Control then appears in the image. This can be operated the same way as the one in the web browser. Only the image sensor (left, right, both) is selected by directly clicking one of the three corresponding rectangular symbols in the top part of it.



Click **Compass** in the toolbar to store the settings you have made. Click on the **Image** menu item from the **Image Formats and Views** option to hide the toolbar again.

Adjusting The Panorama Image In MxControlCenter

You can also use MxControlCenter (MxCC) to configure the panorama view of a D15D-Pano.

First select the D15D-Pano that you would like to configure and then open the **PTZ Control** controls on the left-hand sidebar of MxControlCenter. Click on the **Activate** button under configuration of the panorama view.

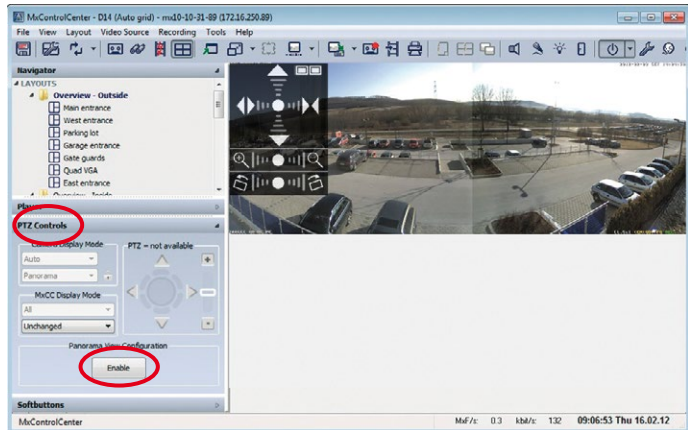

The OnScreen Control of the web browser now appears in the live image of the camera on the right. To activate it, hold down the **Alt key** and click the area in the OnScreen Control at the same time. Adjust the panorama image while holding down the Alt key. Finally, store the settings you have made by **clicking** on the **Deactivate** button (in the PTZ Control controls).

3.4.3 Dual Image Exposure

Generally, the exposure settings for the D15D are carried out automatically. Alternatively, settings can be made manually or separately for each sensor image using custom configurable exposure windows. You can either select a factory default exposure window (via the **Exposure control** Quick Control) or define a custom exposure window (via **Setup Menu > Exposure Settings**) using the **web browser**.

The **Coupled image control** exposure setting is generally always activated in order to create an evenly lit, harmonious dual image with the D15D-Pano (with two individual images combined to create a panorama image). This setting determines the best average exposure value for the combined panorama image and sets this value automatically.

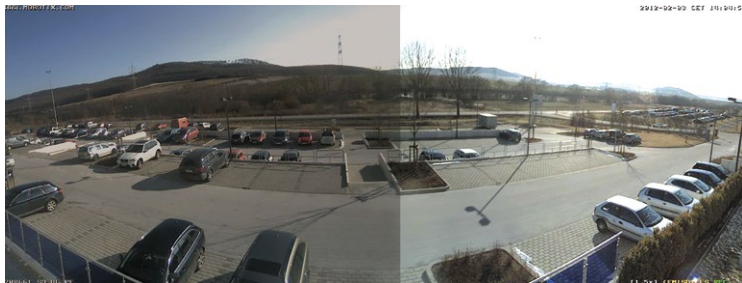

Without coupled exposure control



With coupled exposure control (dual image exposure)

This function is also available for every standard D15D. This function ensures that both camera images in the combined dual image appear equally bright so that it is easier for the observer to associate these images with the same camera and/or the same mounting location.

To activate coupled image control in the web browser, go to **Setup Menu > Exposure Settings** and check the **Coupled image control** item. Then save your setting by clicking **Set** and **Close**.

More robust than hard drives: flash drives for recordings

3.5 MicroSD Card Recording

3.5.1 Introduction

Flash-based storage devices (MicroSD cards, USB flash drives and solid-state drives) do not contain any moving parts as compared to the commonly used hard drives. Flash-based storage devices are compact and highly resistant to moisture and vibrations. They feature low energy consumption and they do not lose any data in the event of a power failure, meaning that they are ideal for use with MOBOTIX cameras.



Number Of Write/Delete Cycles Per Flash Storage Cell

The number of write/delete cycles of every storage cell of a flash device is limited. The controller of the flash device automatically detects individual flash cells that are no longer functioning. The contents of the faulty cell will then be rebuilt using a checksum and will be moved to a properly working spare cell. The faulty storage cell will be marked as "bad" and will no longer be used. No data is lost in this process.

In addition, MOBOTIX cameras can constantly monitor activated flash storage devices. MOBOTIX has developed a technology to test the wear of the flash device by logging the number of write/delete cycles (patent pending). The flash memory wear is automatically displayed in the status bar in the live camera image but it can also be viewed at any time in the **Admin Menu > Camera Status** dialog box.

Low Memory Usage Thanks To MOBOTIX MxFFS File System

MxFFS formatting of the MicroSD card means that MOBOTIX camera software will use the flash device as evenly as possible, thus allowing for the maximum possible number of write/delete cycles. This also means that all storage cells of the flash device will be written and deleted with the same frequency, if possible. MOBOTIX technology increases the life of the flash device considerably and also improves the security and the reliability of the storage process.

Storage Requirements And Life Expectancy Of MicroSD Cards

The life expectancy of a MicroSD card increases proportionally to the storage capacity, since the camera software will execute fewer write/delete cycles on each storage cell. The first deletion will begin once the SD card has been filled to capacity (first full cycle).

All specifications are based on calculated averages

32 GB MicroSD Card: Storage Requirements					
	6 fps CIF	6 fps VGA		1 fps MEGA	1 fps QXGA
	M-JPEG	M-JPEG	MxPEG	M-JPEG	M-JPEG
File size single image	15 kB	45 kB	–	120 kB	240 kB
Storage required per second	90 kB	270 kB	75 kB	120 kB	240 kB
Storage required per 24 hrs	7.8 GB	23.5 GB	6.5 GB	10.4 GB	20.8 GB
Time for one full cycle	4 days	1.3 days	4.8 days	3 days	1.5 days

4 GB MicroSD Card: Storage Requirements					
	6 fps CIF	6 fps VGA		1 fps MEGA	1 fps QXGA
	M-JPEG	M-JPEG	MxPEG	M-JPEG	M-JPEG
File size single image	15 kB	45 kB	–	120 kB	240 kB
Storage required per second	90 kB	270 kB	75 kB	120 kB	240 kB
Storage required per 24 hrs	7.8 GB	23.5 GB	6.5 GB	10.4 GB	20.8 GB
Time for one full cycle	12 hours	4 hours	14.4 hours	9.2 hours	4.4 hours

Caution

The MicroSD card's service life depends on production quality and frequency of use. Set the type of recording (event-controlled or continuous recording, frame rate, resolution) according to your specific requirements.

We recommend changing the pre-installed, high-quality 4 GB MicroSD card once a year if you have it constantly set to continuous recording.

Monitoring The Cell Wear Of Flash Storage Devices (Patent Pending)

MOBOTIX uses its own technology for this purpose and has a pending patent. You can view the flash wear in the status bar of the live image or by opening **Admin Menu > Camera Status**. In addition, the camera can also send a warning message (for example, via e-mail) as soon as a critical error is detected when data is written to the SD card (**Admin Menu > Error Notification Function**.). The MicroSD card can then be replaced to ensure that any existing data is not lost.

File Server / Flash Device	
Type	SD Flash Card
File System	MxFFS
Flash Wear	1%
Transfer Buffer Usage	0% (0: 0%, max: 0%)
Lost Event Images	0
Sequences	1 (1 files)
Newest Sequence	1970-01-01 01:00:00 #0
Oldest Sequence	1970-01-01 01:00:00 #0
Current Usage	4.0 MBytes (0.4%)
Max. Size	936 MBytes

Format SD card:
Admin Menu > Storage
on External File Server
/ Flash Device

The **Secure deletion – Slow** option takes several hours. You can also use suitable applications on Windows, Linux/UNIX and Mac OS X systems to repartition and safely erase the SD card.

3.5.2 Formatting The MicroSD Card

Before a MOBOTIX camera can store image and video sequences on a MicroSD card, the card needs to be formatted as MxFFS (MicroSD cards supplied by MOBOTIX are already MxFFS-formatted). The following steps are necessary to format a storage device (**Admin Menu > Storage on External File Server / Flash Device**):

1. Make sure that there is a MicroSD card in the card slot of the MOBOTIX camera.
2. Click **Format** in the **SD Memory Card** line.

3. Note down the characters shown in the **Encryption password** field or enter your own password. Next, click **OK**.

Note: The **Secure deletion – Slow** option will ensure that any data on the MicroSD card is overwritten completely so that the data cannot be recovered in any way. However, keep in mind that this kind of safe formatting takes considerably more time.

4. In the next dialog box, enter the user name and the password of a user of the **admins** group and click **OK** to confirm.

The MOBOTIX camera now starts formatting the card. It takes 5 to 12 minutes to format an 8 GB MicroSD card if the **Secure deletion – Slow** option is disabled. If **Secure deletion – Slow** is enabled, this may take anywhere between 3 and 14 hours.

Once the formatting has been completed, you can activate the MicroSD card for recording (see next section).

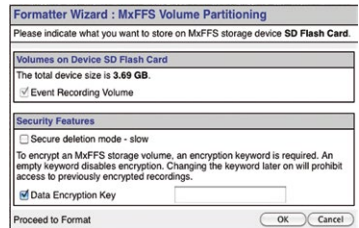

Caution

Make sure that you always wait until the formatting process has been completed before accessing the camera again. If the **Secure deletion – Slow** option is disabled, this usually takes just a few minutes. You can only access the MicroSD card once MxFFS formatting has been completed.

Formatting with the **Secure deletion – Slow** option enabled takes several hours. You can also use suitable applications on Windows, Linux/UNIX and Mac OS X systems to repartition and safely erase the MicroSD card.

3.5.3 Activate Recording

Follow these steps to activate the recording to a MicroSD card that has already been MxFFS-formatted (**Admin Menu > Storage on External File Server / Flash Device**):

1. Make sure that there is a MicroSD card in the card slot of the MOBOTIX camera.
2. Make sure that the MicroSD card is formatted in MxFFS format.
3. Activate the **SD Memory Card** option.
4. Click **Set** and then **Close** to store the configuration.
5. Reboot the MOBOTIX camera (**Admin Menu > Reboot Camera**).

Once the camera has rebooted, make sure that the camera displays the **FR REC** symbols in its live image. If this is the case, the camera uses the MicroSD card as recording target. If not, you must activate the recording (see below).

Activating The Recording

If the **FR REC** symbols are not visible in the live image after rebooting, you need to activate the recording using one of the following methods:

- **In the web browser:** Automatic activation by clicking on the **Arm & Record** softbutton. Confirm this in the Easy Dialog by clicking on the **Yes** button.
- **In the web browser:** Manual activation via the Quick Control **Recording > Recording On** or in **Setup Menu > Recording**.
- **MxEasy:** It is possible to activate the recording based on the time or date using the Alarm Planner of MxEasy (see *MxEasy User Manual*).

Encryption And Authentication

All video data stored on the MicroSD card is encrypted to ensure security at all times. The password for this is defined during the card's formatting procedure and needs to be entered for authentication whenever the recordings are accessed (see next section).

Activate recording:
**Admin Menu > Storage
on External File Server
/ Flash Device**

3.5.4 Accessing Data on the MicroSD Card

The following options facilitate access to the stored image and video sequences on a MicroSD card:

- **In the web browser:** Play back the recorded event images without sound directly from the MicroSD card using the Playback view of the camera software.
- **In MxEasy:** Play back the recorded video sequences with sound by accessing the MicroSD card in the MOBOTIX camera via the camera.
- **In MxControlCenter:** Play back the recorded video sequences with sound by accessing the MicroSD card in the MOBOTIX camera via the camera or by directly accessing the MicroSD card via a card reader connected to the computer. Access the card by setting the MicroSD card's drive/volume as a **Directory** in MxControlCenter.

If the recordings stored on the MicroSD card were encrypted, you need to enter the password used for the encryption before you can access the data. If this is the case, both MxControlCenter and MxEasy will provide a dialog box for this purpose.

Caution

When **using the MicroSD card from one MOBOTIX camera in another MOBOTIX camera**, you need to make sure that the time on the original camera is in sync with the new camera. We recommend using automatic time synchronization via a time server (**Admin Menu > Date and Time**).

3.5.5 Deactivating Card Recording

Follow these steps to deactivate recording to a MicroSD card (**Admin Menu > Storage on External File Server / Flash Device**):

1. Activate the **None** option.
2. Click on the **Set** button at the bottom of the dialog box and then **Close**.
3. Reboot the MOBOTIX camera (**Admin Menu > Reboot Camera**).

Once the camera has rebooted, make sure that the symbol **FR REC** is no longer visible in the bottom right-hand corner of the live image.

4. You can now safely remove the MicroSD card from the camera (see *Section 2.3.6, «Replacing The MicroSD Card»*).

Caution

A **MicroSD card may only be removed from the camera after you have deactivated the recording** to MicroSD card and **rebooted the camera**. **Failing to do so may lead to data loss!**

Removing connected flash storage devices from the camera without properly deactivating them may lead to data loss and/or destroy certain sectors of the storage device. This is limited to 4 MB of lost data per incident due to MxFFS formatting.

3.5.6 Using A MicroSD Card In A Different MOBOTIX Camera

A MicroSD card containing recorded data from a MOBOTIX camera can be inserted into any MicroSD card-enabled MOBOTIX camera. Once MicroSD card recording has been activated (requires a reboot), the "new" MOBOTIX camera automatically synchronizes with the card and resumes recording. No data is lost in this process. Make sure that you deactivate MicroSD card recording before removing the card from a MOBOTIX camera and then reboot the camera.

If the MicroSD card's contents are encrypted, you need to enter the same password in the "new" camera in the **Admin Menu > Storage on External File Server / Flash Device** dialog box. Otherwise, the camera cannot access the MicroSD card.

3.5.7 Limitations On Warranty When Using Flash Storage Media

MOBOTIX will not assume any responsibility for flash storage devices (for example, MicroSD cards or connected USB storage devices) delivered with or integrated into MOBOTIX cameras. The same applies to damage to flash storage devices or damage resulting from the use of devices that are not supplied by MOBOTIX.

3.6 Configuration In The Browser

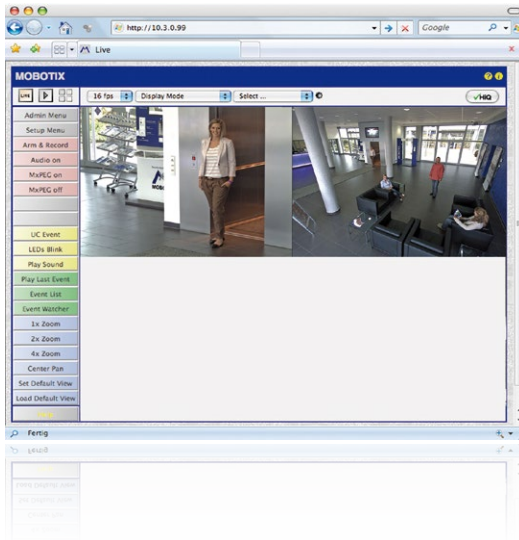

3.6.1 Overview

A MOBOTIXcamera can be completely configured using a JavaScript-enabled browser on all common operating systems (such as Windows, Linux, Apple, etc.). The camera provides a HTML-based user interface for this purpose. The camera executes the changes you make to the camera configuration via HTTP commands using programs and scripts of the embedded software. The settings are stored in the camera's flash memory.

This section contains an overview of the basic browser settings of the MOBOTIX camera as well as further configuration options. Detailed information on the software functions is provided in the camera's online help.

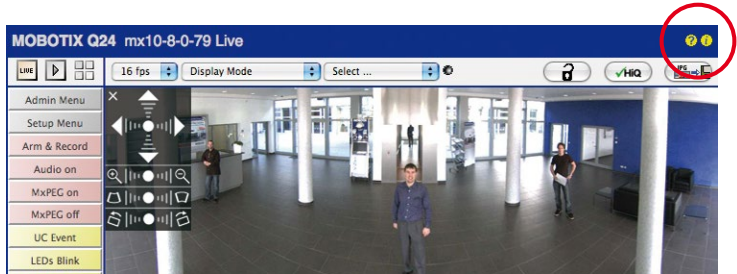

Basic Settings

- **Administering the camera:** You can modify the camera configuration in the Admin Menu or the Setup Menu.
 - **Admin Menu:** This menu contains the basic configuration dialog boxes of the camera (for example, passwords, interfaces, software updates).
 - **Setup Menu:** This menu contains the dialog boxes for configuring the image, event and recording parameters. Some of these settings can be changed using the corresponding Quick Controls in the live view.
- **Resetting changes:** If you would like to reset some larger changes in one dialog box without resetting the complete configuration, you can use the **Default** button at the bottom of the dialog box to reset only this dialog box's settings to the factory defaults. If you would like to reset all image settings, you can do so using the **Manage Settings > Restore Image Settings** Quick Control in the live image of the camera.
- **Storing changes permanently:** Once you have finished configuring the camera, you should always store the settings in the camera's permanent memory. You can do so in each dialog box (clicking on the **Set** button at the bottom of each dialog box will temporarily implement the change; when you click **Close**, you will be asked to store the complete configuration in the camera's permanent memory) or in the Admin Menu (**Admin Menu > Store current configuration into flash memory**). The **Configuration** section of the Admin Menu provides more functions for storing, copying and managing camera settings. For more information on this topic, refer to the online help for the specific dialog boxes.
- **Time tasks and time synchronization:** Apart from a multitude of possibilities for controlling the camera using time (time tables, holiday and vacation, scheduled tasks, etc.), the camera can also synchronize its internal clock. This allows you to manually synchronize the camera with a computer or automatically using a time server or another MOBOTIX camera. The camera can use either NTP time servers or Time Protocol servers. For more information on this topic, refer to the online help for the specific dialog boxes.
- **The "More" and "Less" buttons:** When opening some of the camera dialog boxes, the camera only shows the most important parameters. These dialog boxes have a **More** button in the bottom right-hand corner. Click it to display additional options. If all options are displayed, click on the **Less** button to hide the additional options.

User name: **admin**
password: **meinsm**

Admin Menu

Setup Menu

Make sure to permanently store changed parameters!

Automatic time synchronization using a time server

More:: Display advanced features

Less: Hide advanced features

3.6.2 General Browser Settings

- **Run the Quick Installation:** After booting a new MOBOTIX camera, accessing the administration menu for the first time will automatically start the Quick Installation assistant (**Admin Menu** button). The Quick Installation assistant helps you in setting the most important parameters of the camera. For security reasons, you should set your own administrator password and disable public access to the camera.
- **Disable public access:** Guest users are only allowed to access the Guest screen of the camera without entering a password. If this is not required, you should deactivate public access (**Admin Menu > Quick Installation** or **Admin Menu > Users and Passwords**).
- **Add users and assign access rights:** Similar to a computer operating system, you can add users and user groups and assign the desired rights (**Admin Menu > Users and Passwords**, **Admin Menu > Group Access Control Lists (ACL)**). This approach allows individual access rights to be assigned or denied to camera-specific features based on the user groups.
- **Deactivate the automatic reboot:** In its factory state, every MOBOTIX camera will automatically reboot at 3:36 a.m. every day. All images in the camera's storage buffer will be deleted during this reboot. Images stored on external file servers, internal flash storage, or SD cards will NOT be affected by this reboot. Make sure that you deactivate the automatic reboot if this is not desired (**Admin Menu > Time Tasks**).
- **Optimize the image settings:** The factory image settings of MOBOTIX cameras deliver excellent images for most application scenarios and should therefore not be changed. If you do wish to make changes, your changes should be minor and gradual. You should, however, set an image program according to the application scenario of the camera. Image programs provide a quick and simple method for adjusting the camera to the application scenario as they perform several configuration steps at once (**Image Programs** Quick Control).
- **Set the resolution of the live image:** By default, all MOBOTIX cameras are factory-set to an image resolution of 640 x 480 pixels. You can select the desired resolution using the **Resolution** Quick Control.
- **Adjust the exposure:** The automatic exposure control of the MOBOTIX camera uses individually configurable exposure windows to determine the best image exposure. Open the **Exposure Control** Quick Control and select a predefined set of exposure windows. If required, you can also define custom exposure windows (**Setup Menu > Exposure Settings**).
- **Activate event control and recording:** By default, the MOBOTIX camera's event control is disabled. Click on the **Arm & Record** button to activate event control. This will activate motion detection and recording. Cameras with integrated flash memory (MOBOTIX R models and models with an SD card) will automatically use the flash memory to store image and video data (recording target). If desired, you can set additional events and adjust the settings of the recording and storage parameters (**Setup Menu > Event Settings**, **Setup Menu > Recording** and **Admin Menu > Recording to External File Server / Flash Device**).

- **Set up actions/messaging:** Upon detecting an event, the MOBOTIX camera can trigger alarms. These alarms can be adjusted to your needs and you can assign them to a specific event: playing back an alarm sound on the camera speaker, showing the visual alarm in the camera live image, sending an e-mail or network message with the alarm image, placing a phone call, uploading an alarm image to an FTP server, switching a signal output line of the camera (for example, for switching on the lights/opening a door).

For the settings, see **Setup Menu > Action Group Overview**. The actions to be performed are defined and used in these action groups in the form of "action profiles." The different action profiles can also be defined in the following areas: Admin Menu in the Hardware Configuration (profiles for signal output), Transfer Profiles (FTP, e-mail, network messages) and Sound and VoIP Telephony (sound profiles, VoIP profiles). For more information, refer to the online help for the **Action Group Overview** dialog box.

- **Activate shock detector:** The D15D is also equipped with a shock detector as standard (for all IT and Secure models). If, for example, the camera's housing receives a blow, it automatically registers it and sends a notification via a network message or telephone call. A general advantage is that MOBOTIX cameras are extremely tough because of the absence of mechanical moving parts. This allows them to stay fully operational when they are subject to strong vibrations. Open the **Setup Menu > Event Control > Environment Events > Edit** dialog box if you would like to activate the shock detector (and any other sensors).

3.7 Additional Notes

3.7.1 Password For The Admin Menu

Accessing the Admin Menu of the camera (Admin Menu softbutton) is only possible after entering a user name and password.

- Factory default user name is **admin**.
- Factory default password is **meinsm**.

The Quick Installation assistant automatically appears when the Admin Menu is accessed for the first time. It provides an easy method to adjust the basic camera settings to the current application scenario. For security reasons, we highly recommend changing the default administrator password after the camera has been properly configured.

Enter the user name and password exactly as shown above. Note that all entries are case-sensitive.

Caution

Make sure that you store information on **user names and passwords** in a secure place. If you lose the administrator password and cannot access the administration menu, the password can only be reset at the factory. This service is subject to a fee!

3.7.2 Permanently Deactivating The Microphone

Deactivating a camera's microphone may be necessary in order to protect the privacy of persons at a workplace or for other reasons. You can permanently and irreversibly deactivate the microphone in the **Admin Menu > Loudspeaker and Microphone** dialog box.

Caution

This **deactivation occurs in the camera module itself and cannot be reversed**, even at the factory. Deactivating the microphone will also deactivate all functions that are making use of the microphone.

3.7.3 Starting The Camera With The Factory IP Address

If the camera's IP address is not known, you can start the camera with its factory IP address. This procedure is described in detail in *Section 3.2.6, «Starting The Camera With An Automatic IP Address (DHCP)»*.

3.7.4 Resetting The Camera To Factory Settings

All settings of the MOBOTIX camera can be reset permanently to the factory default settings. This makes sense if you have, for example, obtained a camera without any information

The microphone can be irreversibly deactivated!

You can reset specific parts of the configuration

or you would like to reset all settings after testing the camera. In order to perform this procedure, you need to have administrative access to the camera (**admins** group). Open **Admin Menu > Reset** to reset the camera to factory defaults.

Note

Note: All defined users are deleted and the admin password is reset to the factory default when you reset the camera using **Admin Menu > Reset**. Use the method described in *Section 3.2.6, «Starting The Camera With An Automatic IP Address (DHCP)»* if you would like to maintain the existing users.

3.7.5 Activating Event Control And Motion Detection

In its default configuration, the camera's event control and video motion detection features are not enabled. In order to activate event-controlled recording, open **Setup Menu > General Event Settings** and activate the Arming switch. Another method is to click on the **Arm & Record** softbutton in the browser's user interface. The camera displays the motion detection window in the live image (dotted frame in the center) and the camera automatically stores images as soon as the motion detection window detects movements.

3.7.6 Deactivating Text And Logo Options

As camera arming is deactivated in the camera's default configuration (see preceding section), the MOBOTIX camera only displays the text **www.mobotix.com**, the time stamp and the MOBOTIX logo at the top of the image. Once the camera arming has been activated, the text at the bottom of the live image (event, action, messaging and recording symbols) will also appear.

You can deactivate the status bar at the bottom of the live image and the text bar in the top left-hand corner by setting Text Display in the **Setup Menu > Text & Display Settings** dialog box to **Off**. Setting Text Display to **Date and Time** will only display the time stamp in the live image. To hide the logo in the live image, open **Admin Menu > Logo Profiles** and set Logo Display to **Deactivated**.

3.7.7 Deactivating The Camera Reboot

By factory default, the MOBOTIX camera automatically reboots once a week between 3 a.m. and 4 a.m. The reason for this is that in some rare cases, external influences (for example, radiation at high altitudes) can sometimes lead to camera malfunctions. The automatic reboot will refresh the camera's memory and will ensure proper operation without requiring any interaction on the part of the user. If desired, you can deactivate the automatic reboot of the camera in the **Admin Menu > Time Tasks** dialog box.

3.7.8 Browser

Current Internet browsers (Internet Explorer, Mozilla Firefox, Safari, Google Chrome, Opera, etc.) with enabled JavaScript can display the camera's live images with their standard



If the dotted rectangle in the live image is visible, the camera is armed

Text and logos can be also deactivated or individually configured

settings. Certain browser plug-ins may deactivate JavaScript. If this happens, make sure that you add the MOBOTIX cameras to the respective exception lists.

3.7.9 Cleaning The Camera And Lens

If the lens becomes dirty during the installation process, clean the lens using a lint-free cotton cloth. Make sure that the lens is still in focus after cleaning and adjust its focus if required.

Cleaning The Dome:

- Always mount and unmount the dome using the provided tool (M) in order to protect it from being scratched and from getting dirty.
- You should clean the dome at regular intervals. Always use a soft, lint-free cotton cloth for this purpose.
- If the dirt is more persistent, add a mild alcohol-free detergent without abrasive particles.
- Make sure you instruct cleaning personnel on how to clean the camera.

3.7.10 Safety Warnings

Electrical surges: A range of measures are used to protect MOBOTIX cameras against the effects of small electrical surges. These measures, however, cannot prevent the camera from being damaged when stronger electrical surges occur. Particular care should be taken when installing the camera outside to ensure proper **protection against lightning**, as this also protects the building and the entire network infrastructure.

Electrical installation: Electrical systems and equipment may only be set up, changed and maintained by a qualified electrician or under the direction and supervision of a qualified electrician in accordance with the appropriate electrical guidelines.



Legal aspects of video and sound recording: You must comply with all data protection regulations for video and sound monitoring when using MOBOTIX products. Depending on national laws and the installation location of the D15D, the recording of video and sound data may be subject to special documentation or it may be prohibited.

All users of MOBOTIX products are therefore required to familiarize themselves with all valid regulations and comply with these laws. MOBOTIX AG is not liable for any illegal use of MOBOTIX products.

Network security: MOBOTIX products include all of the necessary configuration options for operation in Ethernet networks in compliance with data protection laws. The operator is responsible for the data protection concept across the entire system. The basic settings required to prevent misuse can be configured in the software and are password-protected. This prevents unauthorized parties from accessing these settings.



3.7.11 Online Help In The Browser

For more information, see the News and Functional Overview pages in the online help of the camera's browser interface. Click on the  icon to open the camera's online help. Furthermore, detailed information on the camera and its current configuration is displayed in the **Camera Status** dialog box when you click on the  icon.

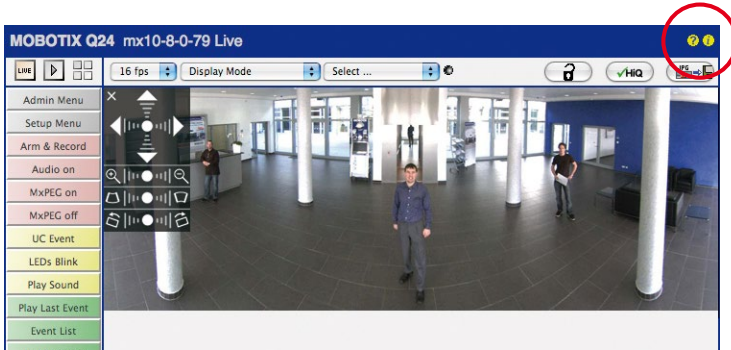

3.7.12 RoHS Declaration

The products of MOBOTIX AG are in full compliance with Art. 5 of the German Electrical and Electronic Equipment Act and the E.U. Directive 2002/95/EC on the Restriction of the Use of Certain Hazardous Substances in Electrical and Electronic Equipment (RoHS) as far as they are subject to these regulations. (You can find the MOBOTIX RoHS Declaration under www.mobotix.com, **Support > Spec Sheets**).

3.7.13 Disposal

Electrical and electronic products contain many reusable materials. For this reason, we would ask that you dispose of MOBOTIX products at the end of their service life in accordance with all legal requirements and regulations (or deposit these products at a municipal collection center). MOBOTIX products may not be disposed of with household waste! If the product contains a battery, please dispose of the battery separately (the corresponding product manuals contain specific directions if the product contains a battery).



3.7.14 Disclaimer

MOBOTIX AG does not assume any liability for damage that is the result of improper use of its products or failure to comply with the operating manuals or the applicable rules and regulations. Our **General Terms and Conditions** apply. You can download the current version at www.mobotix.com (using the **cos** link at the bottom of each page).

Notes

A series of horizontal dashed lines intended for handwritten notes, spanning the width of the page.

Declaration of Conformity
www.mobotix.com >
 Support > MX Media
 Library > Certificates

DECLARATION OF CONFORMITY D15D-DUALDOME

Konformitätserklärung Declaration of Conformity Déclaration de conformité

Hersteller: MOBOTIX AG
Manufacturer:
Fabricant :

Produkt: Netzwerk-Kamera
Product: Network camera
Produit : Caméra de réseau

Typ: D15Di
Type:
Type :

Bei bestimmungsgemäßer Verwendung erfüllt das bezeichnete Produkt die Bestimmungen der im Folgenden aufgeführten Richtlinien:
 The product identified above complies with the essential requirements of the relevant standard, when used for its intended purpose:
 Le produit désigné ci-dessus est conforme aux exigences fondamentales des normes s'y rapportant :

EMV-Richtlinie 2004/108/EG
EMC directive
Directive CEM

Angewendete harmonisierte Normen: EN 55022:2010; CISPR 22:2010
Harmonised standards applied: EN 55024:2010
Normes harmonisées : EN 61000-6-1:2007, EN 61000-6-2:2005

Weitere angewendete Normen: CFR 47, FCC Part 15B
Other harmonised standards applied: C-Tick AS/NZS 3548
Autres normes harmonisées :

Anschrift: MOBOTIX AG
Address: Kaiserstrasse
Adresse : 67722 Langmeil
 Germany

+ TK-Nr. / Phone number / N° de communication :

Fon: +49 6302 9816-0
Fax: +49 6302 9816-190
E-Mail: info@mobotix.com

Langmeil, 13.05.2013

Ort, Datum
Place & date of issue (day/month/year)
Lieu et date



Dr. Ralf Hinkel
 Vorstand/CEO, MOBOTIX AG

Name und Unterschrift
Name and signature
Nom et signature

MOBOTIX - The HiRes Video Company



To demonstrate our confidence in the quality of our products, MOBOTIX cameras have been used to capture all images that appear in this manual.

Manufacturer

MOBOTIX AG
Kaiserstrasse
67722 Langmeil, Germany
Germany

Tel: +49 6302 9816-103
Fax: +49 6302 9816-190

<http://www.mobotix.com>
sales@mobotix.com

Executive Board

Dr. Ralf Hinkel
Registration Office: Kaiserslautern Local Court
Registration Number: HRB 3724
Tax Code: 44/676/0700/4
Tax Office: Worms-Kirchheimbolanden, Germany

VAT ID:
DE202203501

You can find the latest version of this document at www.mobotix.com in the **Support** section.



Technical specifications subject to change without notice!



One Camera. Dual HiRes.

Two lenses, two 5MP HiRes image sensors, up to 64 GB internal storage and a dual image of a maximum of 6 megapixels make the D15D DualDome an efficient security solution: It is possible to secure two different areas using just one camera. All without vulnerable mechanical components!



MOBOTIX D15D Dual Dome - one camera, two views (left: telephoto lens, right: wide angle lens)

HiRes

6 Megapixels

4096 x 1536
Software zoom

Skyline

Format free

Each image format
freely definable

30 Frames/s

VGA (640 x 480)
30 F/s Mega

Virtual PTZ

Digital pan, tilt,
zoom

Backlight

Safe using CMOS
without mechanical iris

Internal DVR

Internal via Flash,
external via Network

Win/Lin/Mac

Recording

via Network on PC
up to 1 Terabyte

Microphone & speaker

Audio

bi-directional via IP,
variable framerates

SIP-Client with video

IP Telephony

Alarm notify,
cam remote control

VideoMotion

Multiple windows
precision pixel-based

-22 to +140°F

Weatherproof

-30 to +60°C, IP65,
no heating necessary

IEEE 802.3af

PoE

Network power
even in winter

Robust

No moving parts
fiber glass housing

MxCC/MxEasy

Licence free

Video-Management-
Software

HiRes Video Innovations

The German company MOBOTIX AG is known as the leading pioneer in network camera technology and its decentralized concept has made high-resolution video systems cost efficient.

MOBOTIX AG • D-67722 Langmeil • Tel: +49-6302-9816-103 • Fax: +49-6302-9816-190 • sales@mobotix.com