

## MOBOTIX D15D DualDome Camera



### One Camera. Dual HiRes.

Two lenses, two HiRes image sensors with 5 megapixels each, up to 64 GB internal storage and a dual image of up to 6 megapixels make the D15D DualDome an efficient security solution: You can secure two different areas with just one camera, for example. All without vulnerable mechanical components!

- Individually configurable lens: Telephoto/wide-angle lens, day/night, panorama function
- Integrated DVR (up to 64 GB) stores up to 520,000 HiRes images (6-day capacity when recording 1 frame/sec.)
- Simple installation using a single network cable (data and power/PoE)
- Digital continuous pan, tilt and zoom function (virtual PTZ function)
- Premium sound and image quality thanks to echo cancellation and 5MP sensor technology
- Optimized interfaces: MxBus and MiniUSB (e.g., for UMTS and GPS)
- Sturdy, low-maintenance and weatherproof from -30 to +60 °C (-22 to +140 °F) (IP65 with wall-mount)
- Microphone, speaker and intelligent movement sensors (MxActivitySensor)

#### MOBOTIX Advantages

Extremely high-sensitive 5-megapixel sensors • All relevant events are automatically saved • Highly secure as motion sensors detect even the smallest movements and reduce the number of false alarms • Cost-effective as fewer cameras are needed thanks to HiRes panorama view • Maintenance-free with no heaters, fans or moving parts • Can be expanded thanks to encrypted two-wire bus (MxBus) • Synchronization via GPS satellite means data available in real time • Weatherproof from -30°C to 60°C (-22°F to 140°F) • No licensing or software fees, free-of-charge updates





Camera Housing	
	<b>Standard housing</b> <ul style="list-style-type: none"> <li>DualDome with two image sensors that can be positioned independently of one another</li> <li>Capture large spaces and details at the same time</li> </ul>

Accessories	
	<b>Vandalism set</b> <ul style="list-style-type: none"> <li>Reinforced dome (3 mm polycarbonate)</li> <li>Stainless steel anti-vandalism ring (polished, matt or powder-coated in white, silver-gray or black)</li> </ul>

	<b>Wall mount</b> <ul style="list-style-type: none"> <li>Weather protection (IP65) for D15-DualDome</li> <li>Covers RJ45 in-wall sockets and functional boxes</li> <li>Space for expansion modules (Wi-Fi)</li> </ul>
---	---

	<b>Corner and pole mount</b> <ul style="list-style-type: none"> <li>3 mm powder-coated stainless steel</li> <li>2 stainless steel straps for pole diameters from 6 to 18 cm, incl. mounting parts</li> </ul>
---	--

	<b>PoE injector</b> <ul style="list-style-type: none"> <li>Power supply via power grid and battery (12 to 42 V)</li> <li>For direct PC connection without a switch thanks to integrated crossover function</li> </ul>
--	---

	<b>MX-232-IO-Box</b> <ul style="list-style-type: none"> <li>For connecting external sensors</li> <li>Switching external devices (e.g., gate, light, etc.)</li> <li>RS232 interface for the camera</li> </ul>
---	--

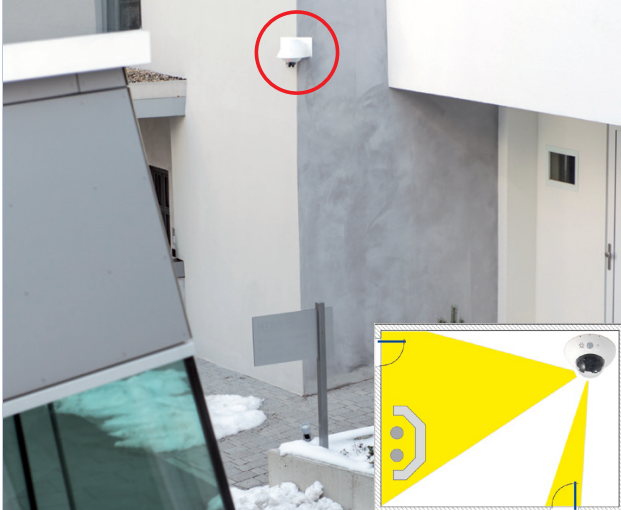
D15D In Use	
	<p>Mounted to the corner of a building, this D15D captures two separate entry zones.</p>

Technical Data	
<b>Model versions</b>	IT, IT-Night, Sec, Sec-Night, Sec-Pano, Sec-Night-Pano, Sec-DNight
<b>Lens options</b>	25 to 160 mm small image, horizontal viewing angle 82° to 13°, pano. version with 164°
<b>Sensitivity</b>	Color sensor: 0.25 lux at 1/60 s, 0.013 lux at 1 s B/W sensor: 0.05 lux at 1/60 s, 0.0025 lux at 1 s MxLEO – Lowlight Exposure Optimization
<b>Image sensors</b>	1/2.5" CMOS, 5 megapixels, progressive scan
<b>Max. image size (per sensor)</b>	Color: 2048 x 1536 (QXGA), B/W: 2048 x 1536 (QXGA)
<b>Image formats (per sensor)</b>	2048 x 1536, 1280 x 960, 1024 x 768, 800 x 600, 768 x 576 (D1), 704 x 576 (TV-PAL), 640 x 480, 384 x 288, 352 x 288, 320 x 240, 160 x 120; free image format selection (e.g. 1000 x 200 for skyline)
<b>Max. frame rate, M-JPEG (live/recording)</b>	VGA: 30 fps, MEGA/HD: 10 fps, QXGA: 4 fps, 6MEGA: 2 fps
<b>Max. video rate MxPEG (live/recording/sound)</b>	VGA: 30 fps, MEGA/HD: 30 fps, QXGA: 20 fps, 6MEGA: 8 fps
<b>Image compression</b>	MxPEG, M-JPEG, JPEG, H.264 (SIP video only)
<b>Internal DVR</b>	MicroSD Slot (recording inside the camera, up to 64 GB; 4-GB card preinstalled)
<b>External storage</b>	Directly on NAS and computer/server without additional recording software
<b>Software (free of charge)</b>	MxEasy video management software, MxControlCenter control center software, MOBOTIX App for iOS devices iOS 5.0 and higher
<b>Image processing</b>	Backlight compensation, automatic white balance, image distortion correction (including panorama image correction), motion detection, MxActivitySensor
<b>Virtual PTZ (vPTZ)</b>	Digital pan/tilt/zoom, continuous 8x zoom, full image recording in the background
<b>Alarm/events</b>	Triggering of events by integrated multiple-window motion detection, external signals, temperature sensor, PIR, notification via e-mail, FTP, IP telephony (VoIP, SIP), signal output, visual/acoustic alarms, pre- and post-alarm images
<b>Audio</b>	Integrated microphone and speaker, line-in/line-out, lip-synchronous audio, intercom, sound recording
<b>Interfaces</b>	Ethernet 10/100, IPv4/IPv6, MiniUSB, MxBus, IO and RS232 via MX-232-IO-Box (accessory)
<b>Video telephony</b>	VoIP/SIP, intercom, remote controlling with key code, event notification
<b>Security</b>	User/group management, HTTPS/SSL, IP address filter, IEEE 802.1x, intrusion detection, digital image signature
<b>Certifications</b>	EMC (EN55022, EN55024, EN61000-6-2, FCC part 15B, AS/NZS3548)
<b>Power supply</b>	Power over Ethernet (PoE in accordance with IEEE802.3af): PoE class variable (2/3) depending on operating mode; power consumption: typ. 5 watts
<b>Operating conditions</b>	IP65 (with wall mount) / IP54 (without wall mount), -30 to +60 °C/-22 to +140 °F
<b>Dimensions</b>	diam. x H: 20.1 x 11 cm
<b>Weight</b>	about 650 g

For more information on the entire range of MOBOTIX accessories and additional information on the D15D, such as prices, manuals, video management software for computers and iOS devices, etc., please go to [www.mobotix.com](http://www.mobotix.com) > **Products**. Or - if you would like to talk to us on the phone to get advice with our products, please call +49 06302 9816-103.

Camera Model	D15Di-IT (Day)	D15Di-IT-Night	D15Di-Sec (Day)	D15Di-Sec-Night	D15Di-Sec-Pano (Day)	D15Di-Sec-Night-Pano	D15Di-Sec-Night-Fix
<b>Lenses, Sensors</b>							
Hemispheric 12 mm (180° x 160°)	–	–	–	–	–	–	–
Super Wide-Angle 25 mm (82° x 61°)	L25	L25	L25	L25	L25	L25	L25
Wide-Angle 38 mm (55° x 41°)	L38	L38	L38	L38	–	–	L38
Wide-Angle 51 mm (40° x 30°)	L51	L51	L51	L51	–	–	L51
Tele 76 mm (27° x 20°)	L76	L76	L76	L76	–	–	L76
Tele 160 mm (13° x 10°)	L160	L160	L160	L160	–	–	L160
Tele 320 mm (7° x 5°)	–	–	–	–	–	–	–
CSVario 28 – 63 mm (28° – 58°)	–	–	–	–	–	–	–
Image sensor with individual exposure zones	Color, Color	B/W, B/W	Color, Color	B/W, B/W	Color, Color	B/W, B/W	Color, BW
Sensor sensitivity in lux at 1/60 s /1 s	0,25/0,013	0,005/0,0025	0,25,0013	0,005/0,0025	0,25/0,013	0,005/0,0025	0,25/0,013 0,005/0,0025
Image sensor (each color or B/W sensor)	5 MP (2592 x 1944)	5 MP (2592 x 1944)	5 MP (2592 x 1944)	5 MP (2592 x 1944)	5 MP (2592 x 1944)	5 MP (2592 x 1944)	5 MP (2592 x 1944)

Hardware Functions							
Protection classes (no accessories/with Outdoor Wall Mount/with Vandalism Set)	IP54/IP65/IP66 and IK10	IP54/IP65/IP66 and IK10	IP54/IP65/IP66 and IK10	IP54/IP65/IP66 and IK10	IP54/IP65/IP66 and IK10	IP54/IP65/IP66 and IK10	IP54/IP65/IP66 and IK10
Temp. range -30 to +60°C/-22 to +140°F	•	•	•	•	•	•	•
Temporary internal DVR	32 MB	32 MB	64 MB	64 MB	64 MB	64 MB	64 MB
Internal DVR, ex works (max. 64 GB)	4 GB (MicroSD)	4 GB (MicroSD)	4 GB (MicroSD)	4 GB (MicroSD)	4 GB (MicroSD)	4 GB (MicroSD)	4 GB (MicroSD)
Microphone/speaker	•/•	•/•	•/•	•/•	•/•	•/•	•/•
Passive infrared sensor (PIR)	•	•	•	•	•	•	•
Integrated temperature sensor	•	•	•	•	•	•	•
Shock detector	•	•	•	•	•	•	•
Power consumption (typical)	< 5 watts	< 5 watts	< 5 watts	< 5 watts	< 5 watts	< 5 watts	< 5 watts
Variable PoE class (factory default: 3)	2 or 3	2 or 3	2 or 3	2 or 3	2 or 3	2 or 3	2 or 3

Image Formats, Frame Rates, Image Storage							
Maximum image format (per sensor)	HD (1280 x 720)	HD (1280 x 720)	QXGA (2048 x 1536)	QXGA (2048 x 1536)	QXGA (2048 x 1536)	QXGA (2048 x 1536)	QXGA (2048 x 1536)
Maximum frame rate (MxPEG, max. resolution)	30 fps (HD)	30 fps (HD)	20 fps (QXGA)	20 fps (QXGA)	8 fps (2x QXGA)	8 fps (2x QXGA)	20 fps (QXGA)
CIF images with 4 GB MicroSD DVR	250,000	250,000	250,000	250,000	250,000	250,000	250,000
VGA images with 4 GB MicroSD DVR	125,000	125,000	125,000	125,000	125,000	125,000	125,000
HD images with 4 GB MicroSD DVR	40,000	40,000	40,000	40,000	40,000	40,000	40,000
QXGA images with 4 GB MicroSD DVR	–	–	20,000	20,000	20,000	20,000	20,000

- available ex works
- not available



Camera Model	D15Di-IT (Day)	D15Di-IT-Night	D15Di-Sec (Day)	D15Di-Sec-Night	D15Di-Sec-Pano (Day)	D15Di-Sec-Night-Pano	D15Di-Sec-DNight-Fix
<b>General Functions</b>							
Digital zoom (continuous) with panning	•	•	•	•	•	•	•
Codecs: Motion-JPEG/MxPEG/H.264 for SIP	•/•/–	•/•/–	•/•/•	•/•/•	•/•/•	•/•/•	•/•/•
Programmable exposure zones	•	•	•	•	•	•	•
Snapshot recording (pre/post-alarm images)	10	10	50	50	50	50	50
Terabyte ring buffer storage (internal/network)	•	•	•	•	•	•	•
Continuous recording with sound (0.2 to 30 fps)	•	•	•	•	•	•	•
Event recording with sound	•	•	•	•	•	•	•
Time and event control/flexible event logic	•/–	•/–	•/•	•/•	•/•	•/•	•/•
Weekly schedules/holidays	•	•	•	•	•	•	•
Web functionality (FTP, email)	•	•	•	•	•	•	•
Playback/QuadView and MultiView	•/•	•/•	•/•	•/•	•/•	•/•	•/•
Bidirectional sound in browser	•	•	•	•	•	•	•
Logo generator, animated	•	•	•	•	•	•	•
Master/Slave arming	–	–	•	•	•	•	•
Several scheduled privacy zones	–	–	•	•	•	•	•
Customized voice messages	•	•	•	•	•	•	•
VoIP telephony (audio/video, alert)	•	•	•	•	•	•	•
Remote alarm notification (network message)	•	•	•	•	•	•	•
Signal inputs/outputs and RS232 via	MX-232-IO-Box	MX-232-IO-Box	MX-232-IO-Box	MX-232-IO-Box	MX-232-IO-Box	MX-232-IO-Box	MX-232-IO-Box
Programming interface (HTTP API)	•	•	•	•	•	•	•
Security Features (HTTPS/SL, IP-based access control, IEEE 802.1X network authentication)	•	•	•	•	•	•	•

Video Analysis							
Video motion detector	•	•	•	•	•	•	•
MxAnalytics	–	–	–	–	–	–	–
MxActivitySensor	•	•	•	•	•	•	•

Video Management Software							
MxEasy (Windows/Mac OS X)	•	•	•	•	•	•	•
MxControlCenter (Windows)	•	•	•	•	•	•	•
MOBOTIX App (iOS)	•	•	•	•	•	•	•



**Delivered Parts D15D (Secure)**



(Excerpt from the technical documentation: [www.mobotix.com](http://www.mobotix.com) > Support > Manuals)

Side

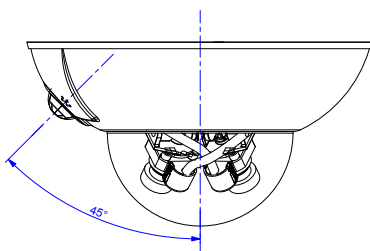

Front

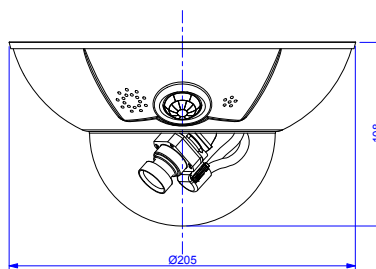

Bottom

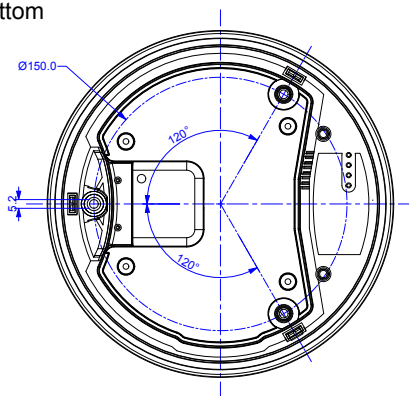

(Excerpt from technical drawings and 3D views: [www.mobotix.com](http://www.mobotix.com) > Support > Image Database)



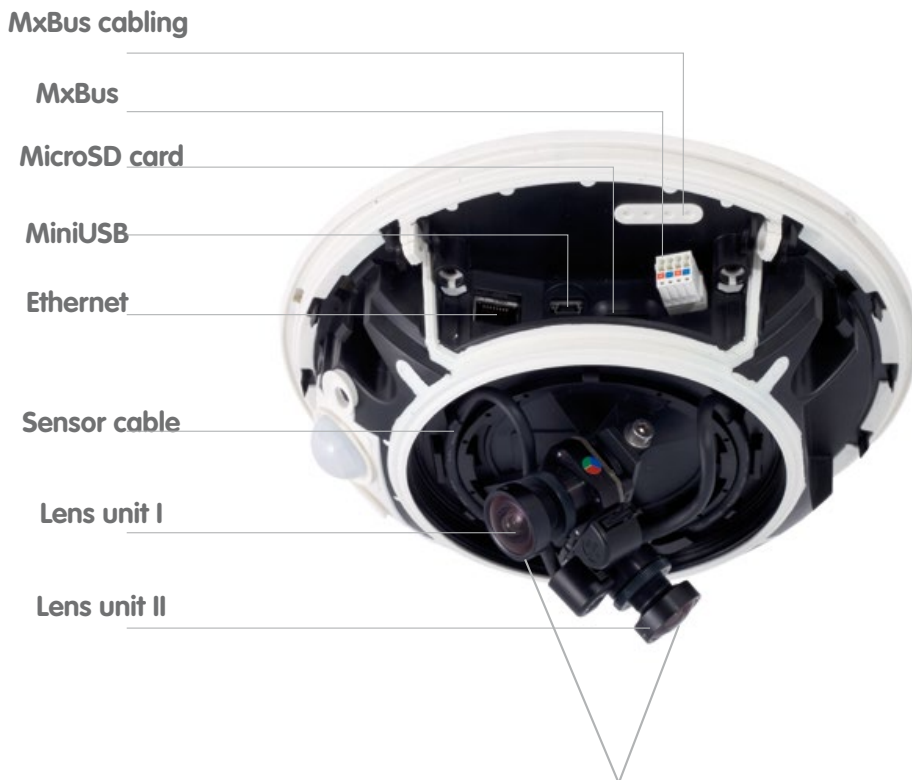

Two freely positionable camera modules

(D15D – Camera housing and connectors, excerpt from the technical documentation)