



Dual. Modular. Unique.

True to the original: The weatherproof, robust successor to our successful MOBOTIX dual camera features interchangeable sensor modules as well as the latest MOBOTIX system technology. As a result, it remains totally unique in terms of performance, functionality and design.

2x L12 to L160 Day or Night



1x L12 to L160 Day or Night



1x Thermal, 1x L12-L160



5MP
Sensor

MxLEO



vPTZ



MxBus

USB

+60°
-30°

IP66



HiRes Video Innovations

The German company MOBOTIX AG is known as the leading pioneer in network camera technology and its decentralized concept has made high-resolution video systems cost efficient.

MOBOTIX AG • D-67722 Langmeil • Tel: +49-6302-9816-103 • Fax: +49-6302-9816-190 • sales@mobotix.com

THE MOBOTIX INFORMATION CHANNELS

**Support on the MOBOTIX Website**

www.mobotix.com/other/Support

**The MOBOTIX Video Tutorials**

www.mobotix.com/other/Support/Tutorials

**Seminars on MOBOTIX Campus**

www.mobotix.com/other/Partners/Seminars

**The MOBOTIX YouTube Channel**

www.youtube.com/MOBOTIXAG

MOBOTIX Seminars

MOBOTIX offers inexpensive seminars that include workshops and practical exercises. For more information, visit www.mobotix.com > **Seminars**.

Copyright Information

All rights reserved. MOBOTIX, the MX logo, *MxControlCenter*, *MxEasy* and *MxPEG* are trademarks of MOBOTIX AG registered in the European Union, the U.S.A., and other countries. *Microsoft*, *Windows* and *Windows Server* are registered trademarks of Microsoft Corporation. *Apple*, the Apple logo, *Macintosh*, *OS X*, *iOS*, *Bonjour*, the Bonjour logo, the Bonjour icon, *iPod* and *iTunes* are trademarks of Apple Inc. registered in the U.S.A. and other countries. *iPhone*, *iPad*, *iPad mini* and *iPod touch* are Apple Inc. trademarks. *Linux* is a trademark of Linus Torvalds. All other marks and names mentioned herein are trademarks or registered trademarks of the respective owners.

Copyright © 1999-2014 MOBOTIX AG, Langmeil, Germany. Information subject to change without notice!

Download the latest version of this and other manuals as PDF files from www.mobotix.com > **Support** > **Manuals**.

CONTENTS

1	Product Overview	10
1.1	M15 AllroundDual	10
1.1.1	General Product Characteristics	10
1.1.2	Hemispheric Sensor Module	15
1.1.3	Advantages And New Features	18
1.1.4	Decentralized Video System	20
1.1.5	Green IP Video	22
1.2	Technical Specifications	24
1.2.1	M15 Lens Options	24
1.2.2	Camera Variants – Lenses, Hardware, Image Formats	26
1.2.3	Camera Variants – Software Features	27
1.2.4	Technical Specifications M15D/M15D-Thermal	28
1.3	Delivered Parts and Dimensions	30
1.3.1	M15 Core (Base Module)	30
1.3.2	M15D-Thermal Model Variant	33
1.3.3	L12 Sensor Module	36
1.3.4	L25, L51 Sensor Modules	38
1.3.5	L38, L76, L160 Sensor Modules	40
1.3.6	M15D Kits “Day/Night”	42
1.4	Available Accessories	43
1.4.1	Polarization Filter	43
1.4.2	MiniUSB Cable to MiniUSB (Straight/Angled)	43
1.4.3	MiniUSB Cable To USB-A Socket	43
1.4.4	Ethernet Patch Cable For Bayonet Catch	43
1.4.5	NPA-PoE-Set	44
1.4.6	MX-Overvoltage-Protection-Box	44
1.4.7	MX-NPA-Box	44
1.4.8	MX-GPS-Box	45
1.4.9	MX-232-IO-Box	45
1.4.10	ExtIO Expansion Module	45
1.4.11	Mx2wire+ Media Converter	46
1.4.12	Mounting Interface Boxes Beneath the VarioFlex Wall Mount	46
1.4.13	Other Accessories	47
1.5	MOBOTIX Software	48
1.5.1	Integrated Camera Software (Firmware)	48
1.5.2	MxControlCenter	49
1.5.3	MxEasy	50
1.5.4	MOBOTIX App	51

2	Installation	52
2.1	Preparing The Installation	52
2.1.1	Installation Options: Wall, Ceiling, Pole	52
2.1.2	Installing The Camera With Hemispheric Sensor Modules	55
2.1.3	Network Connection And Power Supply, UPS	58
2.1.4	Providing the Camera Connections, MX-Overvoltage-Protection-Box	59
2.1.5	Wiring, Fire Prevention, Lightning And Surge Protection	60
2.2	First Installation Steps	61
2.2.1	Initial Installation of the Sensor Modules (except M15D-Sets)	61
2.2.2	Opening the Camera Housing	63
2.2.3	Installing the Security Clips (Optional, Not Required for M15D-Sets)	64
2.2.4	Exchanging Sensor Modules	65
2.2.5	Replacing the Ethernet Patch Cable	66
2.2.6	Connecting a USB Cable	68
2.2.7	Connecting a Two-Wire MxBus Cable	69
2.2.8	Closing the Camera Housing	70
2.3	Mounting The Camera With Wall Mount	72
2.3.1	VarioFlex Wall Mount	72
2.4	Mounting The Camera With Ceiling Mount	76
2.4.1	VarioFlex Ceiling Mount	76
2.5	Mounting The Camera With Pole Mount (Accessories)	80
2.5.1	Pole Mount (MX-MH-SecureFlex-ESWS)	81
2.6	Replacing The MicroSD Card	85
2.7	Network And Power Connection	87
2.7.1	Network Cabling For M15 With Patch Cables	87
2.7.2	Power Supply Using A Switch	88
2.7.3	Power Supply When Connected Directly To A Computer	89
2.7.4	Power Supply With Power-Over-Ethernet Products	89
2.7.5	Variable PoE	90
2.7.6	Camera Startup Sequence	91

3	Operating The Camera	92
3.1	Manual and Automatic Operation – Overview	92
3.1.1	Manually Using A Computer In The 10.x.x.x IP Address Range	93
3.1.2	Automatically Using MxControlCenter Or MxEasy	94
3.1.3	Automatically Using DHCP	95
3.2	First Images And The Most Important Settings	96
3.2.1	Manually Setting Up The Network Parameters In A Browser	96
3.2.2	First Images And The Most Important Settings In The Browser	98
3.2.3	First Images And Network Parameter Configuration In MxControlCenter	100
3.2.4	First Images And Network Parameter Configuration In MxEasy	105
3.2.5	Starting The Camera With The Factory IP Address	108
3.2.6	Starting The Camera With An Automatic IP Address (DHCP)	109
3.3	Adjusting Camera, Lens Focus And Installing Filters	110
3.3.1	Adjusting The Camera	110
3.3.2	Adjusting Lens Focus (L76/L160 Only)	111
3.3.3	Inserting A Filter	112
3.4	Virtual PTZ And Full Image Recording	113
3.4.1	Preparing The Virtual PTZ Function	113
3.4.2	Full Image Recording	115
3.4.3	Special M15 Configuration In The Browser	117
3.5	MicroSD Card Recording	126
3.5.1	Introduction	126
3.5.2	Formatting The MicroSD Card	128
3.5.3	Activating Recording	129
3.5.4	Accessing Data on the MicroSD Card	130
3.5.5	Deactivating Card Recording	130
3.5.6	Using A MicroSD Card In A Different MOBOTIX Camera	131
3.5.7	Limitations On Warranty When Using Flash Storage Media	131
3.6	Configuration In The Browser	132
3.6.1	Overview	132
3.6.2	General Browser Settings	134
3.6.3	Configuring the M15D-Thermal in the Browser	135
3.7	Additional Notes	136
3.7.1	Operation with Only One Sensor Module	136
3.7.2	Password For The Admin Menu	136
3.7.3	Permanently Deactivating The Microphone	136
3.7.4	Starting The Camera With The Factory IP Address	137
3.7.5	Resetting The Camera To Factory Settings	137
3.7.6	Activating Event Control And Motion Detection	137
3.7.7	Deactivating Text And Logo Options	137
3.7.8	Deactivating The Camera Reboot	138

3.7.9	Browser	138
3.7.10	Cleaning The Camera And Lens	138
3.7.11	Legal Notes	139
3.7.12	Safety Warnings	139
3.7.13	Online Help In The Browser	140
3.7.14	RoHS Declaration	140
3.7.15	Disposal	141
3.7.16	Disclaimer	141

Manufacturer

143

Legal Notes

Attention – Special Export Regulations Apply! Cameras with thermal image sensors (“thermal cameras”) are subject to the special export regulations of the U.S.A. and the ITAR (International Traffic in Arms Regulation):

- **According to the currently applicable export regulations of the U.S.A. and the ITAR, cameras with thermal image sensors or parts thereof must not be exported to countries embargoed by the U.S.A. or the ITAR. At present, this applies to the following countries: Syria, Iran, Cuba, North Korea and Sudan. The same export ban applies to all persons and institutions listed in “The Denied Persons List” (see www.bis.doc.gov, “Policy Guidance > Lists of Parties of Concern”).**
- **Under no circumstances can the camera itself or its thermal image sensors be used in the design, the development or in the production of nuclear, biological or chemical weapons or in the weapons themselves.**

Legal aspects of video and sound recording: You must comply with all data protection regulations for video and sound monitoring when using MOBOTIX products. Depending on national laws and the installation location of the M15, the recording of video and sound data may be subject to special documentation or it may be prohibited. All users of MOBOTIX products are therefore required to familiarize themselves with all valid regulations and comply with these laws. MOBOTIX AG is not liable for any illegal use of its products.

Safety Warnings

Installation Instructions:

- This product must not be used in locations exposed to the dangers of explosion.
- Make sure to install this product as shown in *Chapter 2, «Installation»* of this manual.
- When installing this product, make sure that you are only using genuine MOBOTIX parts and MOBOTIX connection cables.
- Make sure that you are installing this product on a solid surface that provides for a sturdy installation of the fixing elements used.

Electrical installation: Electrical systems and equipment may only be installed, modified and maintained by a qualified electrician or under the direction and supervision of a qualified electrician in accordance with the applicable electrical guidelines. Make sure to properly set up all electrical connections.

Electrical surges: MOBOTIX cameras are protected against the effects of small electrical surges by numerous measures. These measures, however, cannot prevent the camera from being damaged when stronger electrical surges occur. Special care should be taken when installing the camera outside of buildings to ensure proper protection against **lightning**, since this also protects the building and the whole network infrastructure.

Max. power consumption of attached extension modules: The power consumption of all attached *MxBus modules* must **not exceed 3 W**. When attaching modules to the MxBus connector **and** the USB connector, the **power consumption of all attached modules must not exceed 4 W, if the camera is powered by PoE class 3**. If **PoE class 2** is used, **the power consumption of all attached modules must not exceed 1 W!**

Never touch the dome or the protective lens covers: Due to the high performance of the M15, the area of the image sensor **can get quite hot**, especially when the ambient temperature is also high. This does not affect the proper functioning of the camera in any way. For this reason, the product must not be installed within the reach of persons without domes or protective lens covers.

Only exchange sensor module when powered off: Make sure the power supply to the camera is disconnected before installing or replacing sensor modules.

Network security: MOBOTIX products include all of the necessary configuration options for operation in Ethernet networks in compliance with data protection laws. The operator is responsible for the data protection concept across the entire system. The basic settings required to prevent misuse can be configured in the software and are password-protected. This prevents unauthorized parties from accessing these settings.





FOREWORD

Dear MOBOTIX customer,

Congratulations on your decision to purchase the M15, the powerful successor to the original MOBOTIX M1/M10/M12, proven one hundred thousand times. This weatherproof (IP66), versatile, all-round solution "Made in Germany" represents an important milestone in the successful history of MOBOTIX products.

As decentralized complete video systems, MOBOTIX cameras have much more to offer than conventional network cameras. The M15 features integrated environment sensors (PIR, outside temperature, motion sensor), speaker and microphone for two-way video communication based on the SIP standard, long-term memory, free video management software and a preassembled VarioFlex wall/ceiling mount, in addition to two HiRes image sensors. The weatherproof MxBus and MiniUSB interfaces allow for direct connection of MOBOTIX interface boxes and standard devices such as UMTS modules, additional memory, etc.

With the M15, one or two separately available MOBOTIX sensors modules (lens plus sensor board and microphone) that can be replaced at any time are used in the M15 Core basic camera module. Twelve different sensor modules are available for the M15: Six focal lengths from telephoto to hemispheric, each available in day or night versions. With the Day&Night models with day and night sensors, the camera switches off to the appropriate sensor depending on the lighting conditions.

The latest five-megapixel technology ensures crisp HiRes images with improved live digital zoom and increased light sensitivity. In conjunction with the maximum image size of 2048x1536 pixels (QXGA), the camera produces clear color images, even at dusk or dawn. At night, a single black and white sensor module now also produces high-resolution images with up to 2048x1536 pixels. If both sensor images are displayed or recorded at the same time, the M15 delivers dual images up to six megapixels.

The new model variant **M15D-Thermal** supplements the proven MOBOTIX technology by a high-end thermal imaging sensor, which can reliably detect moving objects even in total darkness.

The **MxEasy** and **MxControlCenter** video management software, which is tailored to MOBOTIX cameras, and a PDF manual can be downloaded from the MOBOTIX website at no cost: www.mobotix.com > **Support** > **Software Downloads**. MOBOTIX also provides a mobile solution for the iPad, iPhone and iPod Touch iOS devices. Search for "MOBOTIX AG" in the App Store to find the free app.

If you still have any questions, our support and international sales staff are available at int1-support@mobotix.com from Monday to Friday, 8 a.m. to 6 p.m. (German time).

Thank you for choosing MOBOTIX products and services. We wish you all the best with your new, high-performance MOBOTIX M15 AllroundDual camera!



Security-Vision-Systems



1 PRODUCT OVERVIEW

1.1 M15 AllroundDual

1.1.1 General Product Characteristics

The HiRes Dual Camera System For All Your Needs

The M15 AllroundDual camera is a well equipped, professional network camera that is top of the MOBOTIX product range, both in terms of functionality and technological capability. The integration of two image sensors and a range of other functions and technical innovations results in unlimited usage possibilities: For video security applications in commercial, private and public sector environments, as a surveillance or weather camera, a webcam, indoors or outdoors, day or night.

Caution: MOBOTIX In Use!

It is clear from the outset that the M15 is an authentic MOBOTIX camera like its predecessor, the M12. It offers special advantages when a security camera looks like the real thing thanks to its unique, striking product design, which has stood for leading video technology and image quality for many years. This is because potential criminals have developed an eye for spotting high-resolution MOBOTIX cameras and will shy away from them when they see one. Even they know these kinds of video cameras can record all activities with an image quality high enough to be used as evidence, and criminals would rather abandon these attempts and concentrate on less secure prospects.

Modular System Setup

A M15 camera consists of three main components:

1. **Housing** with integrated camera electronics, flash memory, external ports (Ethernet, MxBus, MiniUSB) and pre-installed VarioFlex mount for wall or ceiling mounting.
2. **Front element** to hold one or two sensor modules, with microphone, speaker, passive infrared sensor (PIR), outside temperature sensor and status LEDs.
3. One or two **sensor modules** with lens, image sensor, microphone and status LEDs (microphone and status LEDs are deactivated if attached to a M15). A **M15D-Thermal** comes with thermal image sensor that is pre-installed in the front element and you can install one additional sensor module.

The housing with VarioFlex mount, connection cable for sensor modules and network and the front element are components of the M15 Core basic module as standard. The sensor modules may be ordered separately and combined freely as desired (for example, Day/Night, telephoto/wide-angle). The system's modular design ensures a high level of flexibility and ease of repair (for example, replace one sensor module instead of the entire camera).



Using VarioFlex mount
for installing on a wall or
ceiling (can be upgraded)

The Right Sensor Module For Every Application

Twelve different sensor modules are available for the M15: Six focal lengths from telephoto to hemispheric, each available in day or night versions, with a horizontal image angle of 13°, 27°, 40°, 55°, 82° and 180°.

You can exchange all sensor modules on-site whenever necessary. The image area captured by the camera varies depending on the focal length of the built-in lens. With a Super Wide-Angle lens (82° image angle), for example, almost an entire room can be recorded from just one corner. And a telephoto lens (13° image angle), for example, enables the M15 to clearly record a license plate number from a distance of approximately 75 meters. Or even the serial number of a dollar bill from a distance of two meters.

One M15 camera is usually all that is required to monitor either an entire room or the four lanes of a gas station. The high degree of image detail not only reduces the number of required cameras, but also minimizes system costs by reducing the wiring complexity, emergency power requirements, and number of recording devices required.

5-Megapixel Image Sensor Technology

The M15 features a significantly increased level of performance compared to the previous M12 model. The latest 5-megapixel image sensor technology used in the camera has improved the frame rate as well as the image quality for the up to 3.1-megapixel camera images and brings a new level of detail to your zoomed images (color sensor: +27 %, Black&White sensor: +200 %). Thanks to the new sensors that feature a nearly four times higher light sensitivity, the camera also delivers convincing color images at dusk and in heavy rainfall. At night, the optional black and white sensor now also provides HiRes images up to 2048x1536 pixels (the previous M12 model offered a max. of 1.3 megapixels only), delivering dual images at up to six megapixels during both day and night.

Can Be Used Day And Night

The advantage of a M15D configured as a day-and-night camera is primarily that it continuously uses two sensor modules (one day, one night) rather than relying on a mechanical filter switch, which can be costly to maintain. The MOBOTIX image quality is very good in poor lighting conditions, as the camera uses a real infrared-sensitive, black-and-white image sensor instead of the usual color sensor with electronic color fade-out, whereby the infrared sensitivity is reduced through integrated color filters.

The day and night lenses in the M15 are positioned exactly parallel to one another. This way, the day lens always covers the same area as the night lens.

Hemispheric Day And Night Camera (M15 With Sensor Modules D12 And N12)

The M15 is a hemispheric dual camera for use in extremely variable lighting conditions, equipped with two L12 lenses each with a black/white and color sensor. The M15 is designed in such a way that both of the camera's sensor modules are positioned in parallel in order to see the same image area as a color image during the day and as a black/white image at night.



Robust And Low-Maintenance

The M15 has been manufactured with the highest level of quality in mind always. Only quality-tested, high-grade materials and components are used. MOBOTIX cameras do not have any mechanical motors to operate the lenses or move the camera, making them so robust that maintenance is reduced to a minimum. Cleaning is simple. You only need to wipe the lens using a soft cotton cloth and a mild household detergent without abrasive particles.

Weatherproof – Without Heating Or Fan

The entire camera plus cables and sensor modules are weatherproof (IP66). Thanks to their low power consumption (less than five watts) and the total absence of mechanical

moving parts, M15 cameras feature the highest operating temperature range from -30 to +60°C (-22°F to 140°F). Since the cameras neither fog up nor require heating, power can be supplied via the network cabling according to the PoE standard IEEE 802.3af.

Fast, Simple Installation

The MOBOTIX M15 requires just one cable for data and power to connect to a PoE switch and thereby to any expandable Ethernet network.

The VarioFlex mount supplied as standard makes the camera ideally suited for outdoor use and for installation over in-wall sockets so that the cabling remains perfectly concealed.

A number of additional devices can be used. They are connected via a network switch or directly to the camera housing via an MxBus or MiniUSB cable (for example, ExtIO, MOBOTIX functional boxes, audio devices, flash drives or UMTS/Wi-Fi USB modems). If the network switch features an Internet connection, it can be used for encrypted access to the camera footage from anywhere in the world.

Virtual PTZ (vPTZ) – Panning, Tilting And Zooming With No Motor Required

The M15 also zooms in on detail. This vPTZ function (virtual Pan, Tilt, Zoom) is a standard feature in the integrated camera software. The image can be enlarged using, for example, the mouse wheel, a joystick or a software-controlled PTZ panel, and you can “move” the view to any section of the image. This provides the features of a mechanical PTZ camera without the disadvantages of maintenance and wear.

Simultaneous Zoomed Live Image And Full Image Recording

All standard motorized PTZ cameras only store the image sequence that is currently viewed in the live image (live image recording). This has one serious disadvantage as the recording can only show what has happened in the “visible” portion of the image. The rest is lost and cannot be examined later on. MOBOTIX has hence added the new full image recording feature to the M15. When you activate this feature, the camera will not store the currently viewed image that reflects the pan/tilt position and the zoom setting chosen by the user, but the full sensor image – without vPTZ settings. When examining the recorded images at a later date, the vPTZ features again come into play, as they allow you to zoom in on the visible image and use the pan/tilt features to examine every corner of the recorded full image.

Internal DVR

The M15 features direct recording to the integrated MicroSD card, which makes the camera fully independent of any external storage media, even for longer periods of time. The camera internally stores high-resolution video, without requiring an external recording device or PC and therefore without creating any network load. Old recordings can be overwritten automatically or automatically deleted after a specified period of time. When using a 32 GB SD card, for example, the camera can store more than a quarter million event images in VGA format (640x480). If you would like to archive complete sequences or extracts of sequences, you can export the required data to any PC or USB hard drive.

Low Power Consumption In Accordance With The PoE Standard (IEEE 802.3af)

A M15 uses no more power than its predecessor (typically 4.5 watts), despite the new sensor technology. Adjusting the PoE class via the camera software also enables the use of PoE switches that cannot be operated on all ports with PoE class 3 (up to max. 12.95 V).

Model Variants

The dual camera base module **M15 Core** is available in the **M15D-SEC** model variant, which can be equipped with one or two sensor modules. Each variant features an internal long-term memory (a pre-formatted and pre-installed 4 GB MicroSD card).

The maximum resolution per sensor module is QXGA (2048x1536 pixels, more than 2.5 times larger than Full HD!). The sensor modules themselves are installed in a few easy steps in the basic module (see *Section 2.2.1, «Initial Installation of the Sensor Modules (except M15D-Sets)»*).

MOBOTIX also offers the **M15D Kits** as ready-to-install day/night cameras with the same focal lengths for both image sensors (see *Section 1.3.6, «M15D Kits “Day/Night”»*).

The **M15D-Thermal** model variant has a permanently installed high-end thermal image sensor and can optionally take one more sensor module (day/night/LPF). This means that the M15D-Thermal combines the proven MOBOTIX sensors and event processing capabilities with thermal imaging technology, which can reliably detect moving objects even in total darkness.

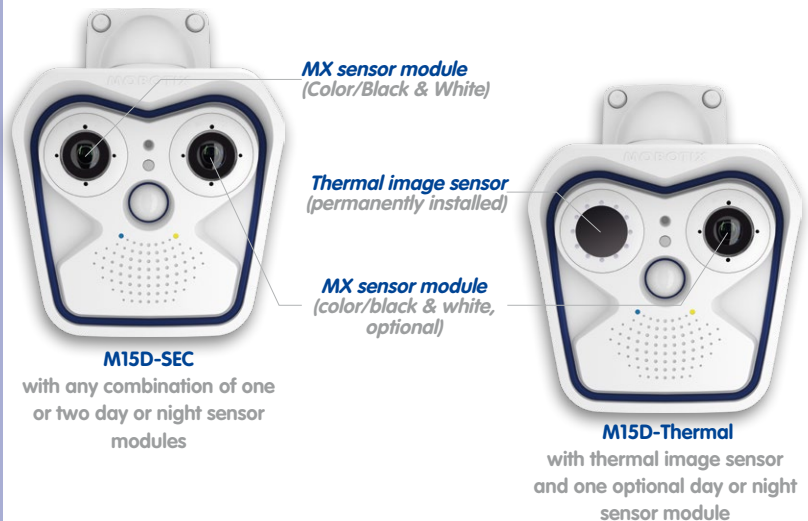

1.1.2 Hemispheric Sensor Module

Equipped with the hemispheric L12 sensor module (day or night), an entire room can be ideally monitored using just one M15, which replaces the time-consuming and expensive installation of several standard cameras. The overview image provided by a single M15, which may be tailored in a number of ways according to specific user requirements, minimizes the system costs by reducing the wiring complexity, emergency power requirements, and number of recording devices required.

High-Resolution Panorama

When several cameras are monitoring a single room, it is difficult to understand the room layout due to the different viewing directions of each individual camera. This makes it hard to comprehend the overall setting. The panorama function of the M15 with the L12 sensor module delivers a widescreen, corrected image of a high-resolution 180° allround view.



Optimizing The Panorama Image

The factory setting of an M15 with an L12 lens is a high-resolution panorama image, in which parts of the protective cover of the housing are still visible in the upper right and left corners of the image. In order to hide the protective cover, often all that is required is the "panorama correction" feature that is integrated into the camera software or MxEasy as standard. Tilted vertical lines (if the camera is mounted at an angle) may be optically

straightened to the image edges using this feature. A welcome side effect of this is that the protective cover disappears from the image.

If this measure does not work in a specific situation (downward camera tilt not possible), the protective cover can be removed from the image by zooming and, if necessary, by panning downward using the virtual functions. The displayed image section or the panorama, as the case may be, is reduced slightly but the image details are enlarged as a result of zooming.



Panorama Focus – One Camera, Three Views

Maximum room overview while simultaneously viewing detail in a single image. The M15 is capable of providing two more views at the same time with the panorama, allowing you to focus on two scenes in parallel ("Panorama Focus" display mode).

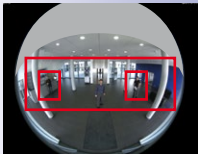

Original full image

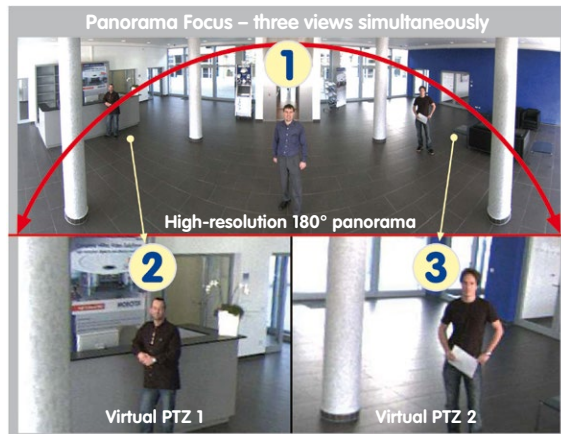

Double Panorama For A Simultaneous View In Two Directions

The "Double Panorama" display mode provides a panorama image of both halves of the surveillance area. Using the vPTZ functions, the panorama images can be changed as desired. The example here shows an overview panorama of the entire room, as well as the entrance, which would have otherwise no longer been visible in the panorama.



Original full image

Surround View (Quad View)

The M15's "Surround" display mode delivers four different directions "at a glance." Each of the four views features a software-controlled pan/tilt/zoom function (virtual PTZ), allowing it to be customized as necessary. In order to facilitate camera operation, the M15 can store a total of 256 user-defined camera views, in addition to the preset standard views.

Full Image And Normal View

In addition to the Panorama, Double Panorama, Panorama Focus, and Surround views, the M15 image may be displayed on a monitor as the original fisheye version ("Full Image" display mode) or as the camera-corrected image section ("Normal" display mode). Switching to one of the other display modes described is possible at any time.

1.1.3 Advantages And New Features

The high-resolution M15 AllroundDual is the more powerful successor to the M12 and features a new, modular system design and five-megapixel image sensors. Although the maximum size at which the images of an M15 sensor can be displayed is 2048x1536 pixels (live or recorded), the M15 outperforms the previous M12 model and other dual cameras on the market in many respects.

Smooth HiRes Video Streams

The M15's optimized hardware doubles the frame rates compared to the M12 and transmits the camera's video streams smoothly, even when high resolution is required. Since image streams of 16 frames per second and higher are perceived as fluid video by the human eye, the maximum frame rate is limited to 30 frames per second (for MEGA resolution) in order to provide sufficient camera processing power for other tasks.

High-Quality Color Images, Even In Low Light Conditions

The more light-sensitive an image sensor is, the better the image quality, especially when the ambient light level is low, such as at dusk and in heavy rainfall. The M15 offers the best MOBOTIX image quality that is currently available thanks to the light sensitivity provided by the five-megapixel color sensor that is four times higher than that of the previous three-megapixel color sensor.

Black and White Resolution Up To 2048x1536 Pixels (QXGA)

HiRes night sensor modules are also available for the M15D. They can deliver black and white images up to 2048x1536 pixels. This means that in pixels alone images are roughly 148 % larger than those delivered by the previous 1.3-megapixel sensor. The images also benefit from the improved detail magnification enabled by the digital zooming of the new sensors (200 % more detail compared to the old sensor).

Black and White Night Sensor Modules with Long-Pass Filter (LPF)

All night sensor modules (N12 to N160, black&white) can be ordered with an LPF (long-pass filter) special lens that is ideal for license plate recognition when combined with infra-red illumination. All LPF sensor modules (except for L12) can be equipped with an additional polarizing filter.

More Details When Zooming

The maximum zoom factor of the M15 color sensors is 1.27 times higher than that of the M12 due to the use of five-megapixel technology. Image detail is improved by 27 percent. As a result, an M15 can now be installed even further away than before from the objects and areas to be monitored. In addition, this relativizes the horizontal image angles of the new five-megapixel sensors that are slightly smaller compared to the M12.

Flexible And Future-Proof

The system can easily be matched to suit the location’s requirements, thanks to a range of available sensor modules. You can change the sensor modules to modify the focal lengths at any time.

New Features Of The M15 Compared To The M12 At A Glance

New	Comment
Modular design	M15 Core: Camera housing with front element; sensor modules may be ordered individually
IP66	Dust-proof and resistant to water jets (M12: IP65)
Sensor modules including lens and image sensor	Up to two can be connected, simultaneous display and recording; installation and expansion by the user (no need to send it back to the MOBOTIX factory)
Black&white sensor modules with LPF	All night sensor modules (N12 – N160) can be ordered long-pass filter (LPF)
Flash memory (internal DVR)	MicroSD card replaces SD card and R models of the M12
MiniUSB	For peripheral devices, adapter cable available from MOBOTIX
MxBus	Enables the two-wire connection of MOBOTIX interface boxes
Power supply	Via a blue NPA-PoE-Set, MX-NPA-Box or standard PoE switch
RS232 connector	Can be used with MX-232-IO-Box via USB (MOBOTIX accessories), Sub-D HD-15 (M12) discontinued
Shock detector	Reports acts of vandalism, etc. to the M15 camera housing
MxActivitySensor	Detects movements of people/objects and the directions of movement
Outside temperature sensor	Integrated into the front element of the M15 Core module
Mobile video remote station	M15 operation is integrated in the MOBOTIX App for iOS devices
Thermal Image Sensor	The M15D-Thermal model variant has a permanently installed thermal image sensor and can optionally take one more sensor module (day/night/LPF).

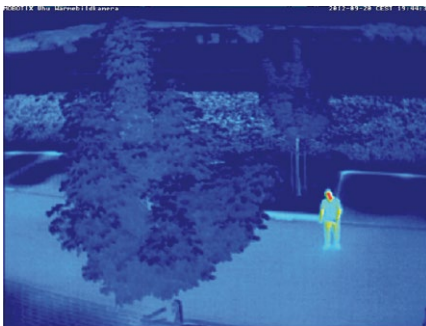

Thermographic image of a M15D-Thermal in offset colors

1.1.4 Decentralized Video System

Usually, cameras only supply images, while processing and recording take place later on a central PC using video management software. This centralized structure has too many limitations for high-resolution video systems since it requires high network bandwidth and the PC processing power is insufficient when using several high-resolution cameras. Due to the large number of computers and servers required, traditional centralized systems are therefore becoming less suitable and cost effective.

As part of the decentralized MOBOTIX concept, every camera features a **high-speed processor**, and, if necessary, digital **long-term flash memory** (MicroSD card) can be integrated to provide several days of recording time. The computer or video control center is required only to view and control the cameras, not to evaluate and record video. This means that you do not have to rely on expensive, overloaded video management software as most of the important functions that require a large amount of processing power are integrated into the MOBOTIX cameras themselves.

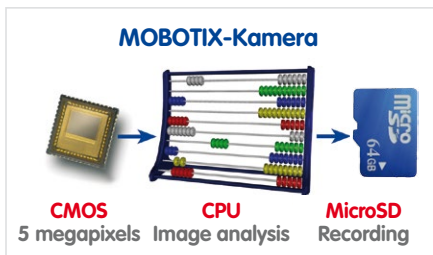

Integrated sensors enable MOBOTIX cameras such as the M15 to automatically detect when an event has occurred. If necessary, the cameras will respond immediately with an alarm sound and will establish a direct video and sound connection to a control room.

M15 IT/SEC models utilize MxActivitySensor to detect the movement of people and objects and their direction of movement as standard. The MxActivitySensor delivers reliable results particularly in outdoor area applications, in contrast to video motion detection that continues to be available and that registers even the smallest of image changes in defined video motion windows. In the defined monitored area (full image or section), the camera distinguishes between the continuous movements of vehicles, persons or objects that trigger an alarm and movements that do not set off an alarm such as shadows, changing light conditions, heavy rain or trees swaying in the wind.

The M15 is also equipped with a **shock detector** as standard (for all IT and SEC models). For example, if the camera receives a blow to the housing, it can simultaneously take a video of the offender, trigger a sound alarm and notify the security company by a SIP call. Due to the build quality and absence of moving parts, MOBOTIX cameras are extremely tough. This typically allows them to stay fully operational, even when they are subject to strong vibrations.

All MOBOTIX cameras are **backlight-proof** and are not adversely affected by the glare from direct sunlight. They deliver meaningful, detailed images at all times as the camera software supports easy programming of independent exposure windows, making them ideal for rooms with large glass fronts.

MOBOTIX In the event of an alarm, M15 cameras can also record **lip-synchronous audio**. The cameras therefore play an important role in analyzing and clarifying a situation. Thanks to an integrated speaker and microphone, each individual camera can also be used for **bidirectional communication** (two-way video communication), so you can easily use the MOBOTIX App with your iPhone or iPad on the road.

The **decentralized MOBOTIX video solutions** are superior to traditional systems in all major aspects. They are also considerably cheaper to operate as they require

- **Fewer cameras** due to the more accurate detail of panorama images with megapixel technology
- **Fewer recording devices** because ten times the standard number of cameras can be used to record high-resolution HDTV video with sound on one computer/server simultaneously in the decentralized system
- **Lower network bandwidth** because everything is processed in the camera itself and the high-resolution images therefore do not have to be constantly transmitted for analysis





1.1.5 Green IP Video

The modern, network-based video security technology offers numerous advantages to use energy efficiently. Due to the special product and system properties, the decision to install MOBOTIX video systems is also a decision for Green IP Video: low power consumption and environmental friendly because of long life expectancy and minimal amount of materials involved.

Low Power Consumption

MOBOTIX cameras are cost-efficiently supplied via PoE. This reduces the expenses for power and, in addition, saves copper and other important raw material as less power cabling is necessary.

Robust

MOBOTIX IP66 cameras are highly robust and work – without high-power climate control and extra protective housing – in a temperature range from –30 to +60°C/–22 to +140°F.

Modern

Integrated into the cameras are high-power processors and flash storage, thus making energy-consuming servers and storage devices unnecessary. And, of course, the disposal of waste later.

High Resolution

A hemispheric MOBOTIX camera with two image sensors replaces up to eight standard cameras – including their consumption of energy and resources.

Sustainable

Without mechanical components, MOBOTIX cameras are maintenance-free and stay fully functional, even after years – and are, thus, more sustainable compared to other systems.

Forward-Looking

Even previous camera models can be easily updated and then offer new functionalities. Remote updates via the internet and the fact that the cameras are maintenance-free reduce trips by car, and, thereby, the negative effect on the environment.



1.2 Technical Specifications

1.2.1 M15 Lens Options

Since **MOBOTIX cameras are backlight-proof, none of the lenses requires a mechanical auto iris.** This makes the cameras extremely robust and maintenance-free.

M15D-SEC With All Sensor Modules

18 different MOBOTIX sensor modules are available for the M15D (each available in day, night and LPF versions):

- L12 Fisheye with 180° horizontal field of view
- L25 Super Wide-Angle with 82° horizontal field of view
- L38 Wide-Angle with 55° horizontal field of view
- L51 Wide-Angle with 40° horizontal field of view
- L76 Telephoto with 27° horizontal field of view
- L160 Telephoto with 13° horizontal field of view

The integrated virtual PTZ features of the camera software or MxControlCenter/MxEasy properly correct the lens distortion in the L12 Fisheye that is specific to each lens. The **L25 Super Wide-Angle lens** delivers good image quality, even when the maximum digital zoom is used. If the M15 is installed in the corner of a room with this lens, almost the complete room will be visible on the image.



MOBOTIX Original image
L25 Super Wide-Angle



M15D-Thermal With Optional MX Sensor Module

This model variant has a permanently installed thermal image sensor and can optionally take one more sensor module (see above). The thermal image sensor is available in these focal lengths:

- L43 with 45° horizontal field of view
- L65 with 25° horizontal field of view
- L135 with 17° horizontal field of view

Five-Megapixel Sensor Lenses	L12	L25	L38	L51	L76	L160
Original image						
35 mm equivalent	12 mm	25 mm	38 mm	51 mm	76 mm	160 mm
Nominal focal length	1.8 mm	4 mm	6 mm	8 mm	12 mm	25 mm
Aperture	2.0	2.0	2.0	2.0	2.0	2.5
Horizontal image angle	180°	82°	55°	40°	27°	13°
Vertical image angle	160°	61°	41°	30°	20°	10°
At 1 m distance						
Image width	infinite	1.7	1.0	0.7	0.5	0.2
Image height	11	1.2	0.7	0.5	0.4	0.2
At 5 m distance						
Image width	infinite	8.7	5.2	3.6	2.4	1.1
Image height	55	5.9	3.7	2.7	1.8	0.9
At 10 m distance						
Image width	infinite	17.4	10.3	7.2	4.9	2.3
Image height	110	11.9	7.5	5.4	3.6	1.7
At 20 m distance						
Image width	infinite	34.7	20.6	14.5	9.7	4.6
Image height	220	23.7	14.9	10.8	7.2	3.4
At 50 m distance						
Image width	N.A.	86.8	51.5	36.2	24.3	11.4
Image height	N.A.	59.3	37.3	27.0	18.0	8.6

Notes



The specified focal lengths of the MOBOTIX lenses do not reflect the actual focal length of the lenses, but the focal length (Lxx mm) converted to 35 mm camera format. For example, the MOBOTIX L25 Super Wide-Angle lens has an actual focal length of 4 mm. This would be the equivalent of 25 mm on a 35 mm camera. It is therefore referred to as an L25. Since the image sensors in digital cameras have different sizes, converting the focal lengths to 35 mm camera as a known format allows the image formats and the fields of vision of the different lenses to be calculated and compared more easily. Another benefit is that you can easily set a 35 mm camera (analog or digital) to the same focal length as the MOBOTIX lens (Lxx) to obtain the same field of vision. This approach greatly facilitates lens selection.

M15D sensor modules can be freely interchanged

Sensor modules L25 through L160 provide a non-reflective protection layer made of **tempered glass**

Focal lengths of MOBOTIX lenses are always given as compared to a 35 mm camera!

1.2.2 Camera Variants – Lenses, Hardware, Image Formats

Camera Model		
	M15D-SEC	M15D-Thermal
Lenses, sensors		
Hemispheric 12 mm (right/left)	•/•	-/•
Super Wide-Angle 25 mm (right/left)	•/•	-/•
Wide-Angle 38 mm (right/left)	•/•	-/•
Wide-Angle 51 mm (right/left)	•/•	•/•
Tele 76 mm (right/left)	•/•	•/•
Tele 160 mm (right/left)	•/•	•/•
Image sensor with individual exposure zones	Color/BW/LPF (any combination)	Thermal image sensor (+ optional color/BW/LPF)
Image sensor sensitivity in Lux at 1/60 s/1 s	0.25/0.013 or 0.05/0.0025 (BW/LPF)	NETD typ. 50 mK, <79 mK (color/BW/LPF see left)
Image sensor resolution	5 MP (2592x1944 pixels)	336x252 pixels/ (color/BW/LPF see left)
Hardware Features		
IP protection class	IP66	IP66
Temp. internal DVR (MB)	64	64
Internal DVR (MicroSD, up to 64 GB)	4 GB included	4 GB included
Microphone/Speaker	•/•	•/•
Passive infrared sensor (PIR)	•	•
Internal/ambient temperature sensor	•/•	•/•
Shock Detector	•	•
Power consumption in Watts (typical)	< 4.5 W/< 5 W	< 5 W/< 5.5 W
Variable PoE class	2 – 3	3
Image Formats, Frame Rates and Image Storage		
Max. image size (per sensor)	QXGA (2048x1536)	QXGA (2048x1536)
Max. frame rate (MxPEG, max. resolution)	20 fps	20 fps
CIF images with 4 GB MicroSD DVR	250,000	250,000
VGA images with 4 GB MicroSD DVR	125,000	125,000
MEGA images with 4 GB MicroSD DVR	40,000	40,000
QXGA images with 4 GB MicroSD DVR	20,000	20,000

1.2.3 Camera Variants – Software Features

Camera Model	
	M15D-SEC/M15D-Thermal
General Features	
Digital zoom (continuous) with panning	•
Motion JPEG/MxPEG/H.264 codecs	•/•/• (only SIP video)
Custom exposure windows	• (not for thermal sensor)
Snapshot rec. (pre-/post-alarm images)	50
Terabyte ring buffer (internal/network)	•
Continuous rec. with sound (0.2 to 30 fps)	•
Event recording with sound	•
Time and event control	•
Weekly schedules/holidays	•
Web functionality (FTP, email)	•
Playback/Quad and MultiView	•
Bidirectional audio in browser	•
Logo generator, animated	•
Flexible event logic	•
Master/slave arming	•
Several scheduled privacy zones	•
Customized voice messages	•
VoIP telephony (audio/video, alarm)	•
Remote alarm notification	•
Signal inputs/outputs, RS232	Via MX-232-IO-Box
Programming interface/HTTP API	•
Security features (HTTPS/SSL, IP-level access control, network authentication IEEE 802.1X)	•
Video Analysis	
Video Motion detection	•
MxAnalytics	–
MxActivitySensor	•
Video Management Software	
MxEasy, MxControlCenter	•
MOBOTIX App	•

1.2.4 Technical Specifications M15D/M15D-Thermal



M15D with two MX sensor modules (Day/Night/LPF)



M15D with one MX sensor module (Day/Night/LPF)



M15D-Thermal with one add. MX sensor module (Day/Night/LPF, optional)

Technical Specifications M15D/M15D-Thermal	
Model Variants	MX-M15D (any combination of Day/Night/LPF sensor modules) MX-M15D-Thermal (optionally 1 add. Day/Night/LPF sensor module)
Lens options MX sensor module	12 to 160 mm (in 35 mm format), 180° to 13° horizontal field of view
Lens options thermal image sensor	43, 65, 135 mm (in 35 mm format), 45°, 25°, 17° horizontal field of view
Sensitivity MX sensor module	Color sensor: 0.25 Lux at 1/60 s, 0.013 Lux at 1 s B&W sensor: 0.05 Lux at 1/60 s, 0.0025 Lux at 1/1 s, MxLEO – MOBOTIX Lowlight Exposure Optimization
Sensitivity thermal image sensor	NETD typ. 50mK, <79 mK, IR range 7.5 to 13.5 μm Range of temperature measuring: -40 to +550°C/-40 to +1,022°F
Image sensor MX sensor module	1/2.5" CMOS, 5 MP (2592x1944 pixels), progressive scan
Image sensor Thermal image sensor	Uncooled microbolometer, 336x252 pixels
Max. image size MX sensor module	Color: 2048x1536 (QXGA) Black & White: 2048x1536 (QXGA)
Max. image size Thermal image sensor	Can be scaled up to 2048x1536 (QXGA), automatically scaled to size of MX sensor module
Max. image size with two sensor modules (dual image)	Color: 4096x1536 Black & White: 4096x1536
Image formats (independent of type, per-sensor setting)	2048x1536 (QXGA), 1920x1080 (Full HD), 1280x960 (MEGA), 1280x720 (HD), 1024x768, 800x600, 768x576 (D1-PAL), 704x576 (TV-PAL), 640x480, 384x288, 320x240, 160x120, custom formats
Max. frame rate M-JPEG MX sensor module (live/recording)	VGA: 30 fps, MEGA: 10 fps, QXGA: 4 fps, 6MEGA: 2 fps
Max. frame rate MxPEG MX sensor module (live/recording)	VGA: 30 fps, MEGA: 30 fps, QXGA: 20 fps, 6MEGA: 8 fps
Max. frame rate Thermal image sensor	9 fps (when displaying thermal image sensor and MX sensor module, the overall frame rate of the camera is reduced to 9 fps)
Image compression	MxPEG, M-JPEG, JPEG, H.264 (SIP video only)
Internal DVR	MicroSD slot including 4 GB, max. 64 GB
External video ring buffer	Up to 4 TB directly on NAS and PC/Server, no additional recording software required
Software (included)	MxEasy video management software, MxControlCenter control center software, MOBOTIX App for iOS devices version 5.0 and higher

Technical Specifications M15D/M15D-Thermal	
Image Processing	Backlight compensation, automatic white balance, image distortion correction, panorama correction, video sensors (video motion detection/MxActivitySensor), optional offset-color/black & white display of thermal image sensor
Virtual PTZ	Digital pan/tilt/zoom, continuous up to 8X
Alarm/events	Video Motion detection, MxActivitySensor, external signals, temperature sensor, PIR, microphone, shock detector, notification via e-mail, FTP, IP telephony (VoIP, SIP), visual/acoustic alarms, pre- and post-alarm images
Microphone and speaker	Microphone and speaker integrated
Audio features	Lip-synchronous audio, two-way communication, audio recording
Interfaces	Ethernet 10/100, MiniUSB, MxBus; inputs/outputs and RS232 via accessories
Video telephony	VoIP/SIP, two-way communication, remote controlling using key codes, event notification
Security	User/group management, HTTPS/SSL, IP address filter, IEEE 802.1x, intrusion detection, digital image signature
Certifications	EMV (EN 55022, CISPR 22, EN 55024, EN 61000-6-1/2, FCC Part15B, CFR 47, AS/NZS 3548)
Power supply	Year-round Power-over-Ethernet (IEEE 802.3af); PoE class variable (M15D-Thermal: class 3 required)
Power consumption	M15D-SEC: Typical < 4.5 W with 1 sensor module, < 5 W with 2 sensor modules M15D-Thermal: Typical < 5 W with thermal image sensor, < 5.5 W with 1 additional sensor module
Operating conditions	IP66, -30 to +60°C/-22 to +140°F, max. humidity 90 to 100% (EN 50155 chapter 12.2.5)
Shock resistance	IK06 (IEC 62262/EN 50102)
Dimensions M15D; M15D-Thermal	W x H x D with wall mount: 158 x 244 x 239 mm; W x H x D with ceiling mount: 158 x 210 x 207 mm
Weights M15D without sensor modules	Weight with wall mount: approx. 1,129 g Weight with ceiling mount: approx. 1,078 g
Weights M15D-Thermal without add. sensor module	Weight with wall mount: approx. 1,210 g Weight with ceiling mount: approx. 1,160 g
Dimensions/Weights sensor modules	L12: Ø x H: 43 x 45 mm (installation dim.), weight 85 g L25, L51: Ø x H: 43 x 57 mm (installation dim.), weight 111 g L38, L76, L160: Ø x H: 43 x 60 mm (installation dim.), weight 122 g
Standard Delivery	Housing (high-resistance composite, PBT), white, shock-resistant dome for L12 sensor module, coated glass pane for all other MX sensor modules, protective Germanium cover for thermal image sensor (only M15D-Thermal), accessories for installation on wall and ceiling, Allen wrench, 50 cm patch cable, manual, software, 4 GB MicroSD card (installed)

Visit www.mobotix.com and go to **Products > M15 AllroundDual**. In the shopping basket, open the **Product Configurator** and use it to order the required parts (e.g., sensor modules).

1.3 Delivered Parts and Dimensions

1.3.1 M15 Core (Base Module)



Standard Delivery

Item	Count	Part Name
1.1	1	Camera housing with mainboard and wall mount (installed), without sensor modules and front element
1.2	1	Front element with additional sensors (installed)
1.3	2	Transport plugs (installed)
1.4	1	Dummy module (must be installed when using only one sensor module)
1.5	4	Inner housing cover (installed)
1.6	4	Stainless steel Allen screw with flat head M4x8 for inner housing cover (installed)
1.7	2	Cable lock black with bayonet catch (Ethernet patch cable, USB, one mounted, one supplied)
1.8	2	Single wire plug, blue (MxBus, USB, mounted)
1.9	1	MicroSD card 4 GB (installed)

Standard Delivery		
Item	Count	Part Name
1.10	1	Ethernet patch cable, 50 cm/19.7 in with sealing (installed)
1.11	2	Sensor module cable 15 cm/6 in (installed in camera)
1.12	1	I/O cable with red clips to front element 15 cm/6 in (installed)
1.13	1	Hinged ferrite for Ethernet cable (installed)
1.14	2	Hinged ferrite for sensor module cable (installed)
1.15	2	Rubber plug for covering mounting screws, white
1.16	3	Stainless steel Allen screw M6x30 (installed)
1.17	3	Stainless steel washer Ø 6.4 mm (installed)
1.18	1	Stainless steel spring washer Ø 6.4 mm (wall/ceiling mt, installed)
1.19	1	Stainless steel lock nut M6 (wall/ceiling mount, installed)
Mounting Supplies		
M.1	4	Stainless steel washer Ø 6.4 mm
M.2	4	Dowels 8 mm
M.3	4	Stainless steel wood screw with hex head 6x50 mm
M.4	1	Allen wrench 2.5 mm
M.5	1	Allen wrench 5 mm
M.6	1	Lens wrench (L12 lens, glass/filter insert, dome)
M.7	1	Module key (sensor module, focusing of lenses)
M.8	1	Rubber sealing for wall/ceiling mount, white
M.9	1	Ceiling mount for VarioFlex mount
M.10	4	Protection cover for screw, white
M.11	4	Security clip for sensor or blind modules, red

Design of the MOBOTIX M15

The Base module of the MOBOTIX M15 consists of the camera housing with VarioFlex mount (wall or ceiling) and the front element.

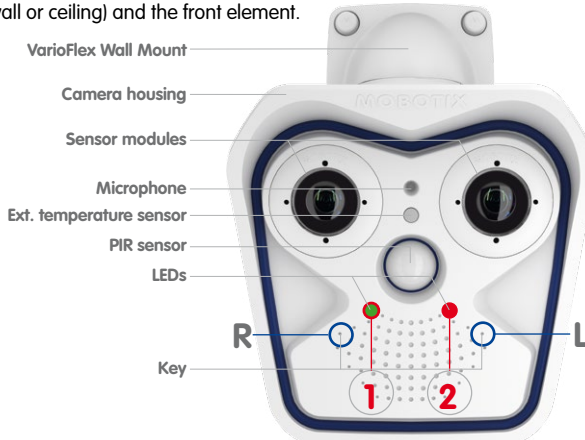

LED default settings

- 1 Power (an), Error (flashes)
- 2 Recording (flashes)

To press a key, use a paper clip for example, but never use sharp or pointed objects!

Connections of the MOBOTIX M15

The MOBOTIX M15 has the following connections that are accessible once the housing has been opened (see *Section 2.2.2, «Opening the Camera Housing»*):

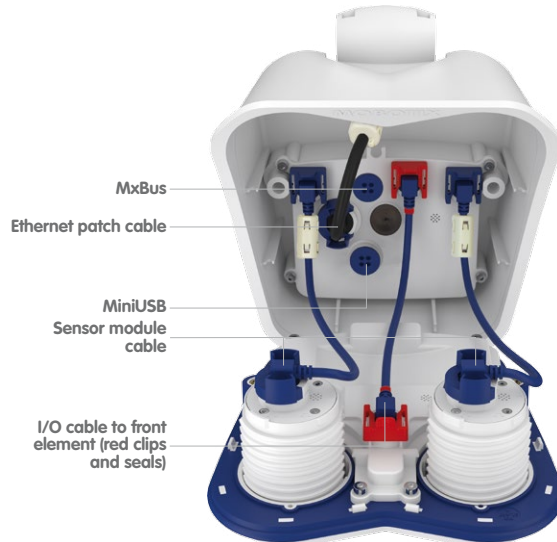

Only use cables with **angled plugs** inside the housing of the M15 (exceptions: patch cables, MxBus connection wires)

Only use the corresponding MOBOTIX cables with sealing ring when using the connections of the M15 shown above:

- Ethernet patch cable: **MX-OPT-CBL-LAN-1/2/5/10**
- MiniUSB (straight/angled): **MX-CBL-MU-EN-STR-05/2/5**
- MiniUSB to USB-A (angled to USB socket): **MX-CBL-MU-EN-AB-05/2/5**

1.3.2 M15D-Thermal Model Variant

The delivered parts of the M15D-Thermal are slightly different from those of the **M15 Core** (see Section 1.3.1, «M15 Core (Base Module)»):



Changes in the Delivery of the M15D-Thermal

Item	Count	Part Name
1.2	1	Front element with one thermal image sensor (right) and additional sensors (installed)
1.14	1	Hinged ferrite for sensor module cable (installed)
Mounting Supplies		
M.11	2	Security clip for sensor or blind modules, red

The drilling templates can be found at the end of the manual

Always print or copy drilling template in their original size

Dimensions Of The M15 With Wall Mount



Dimensions Of The M15 With Ceiling Mount

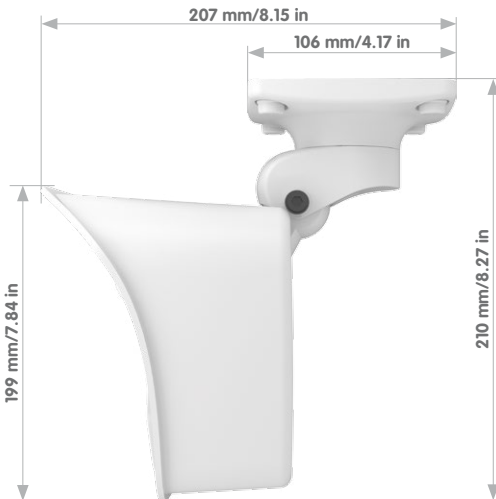
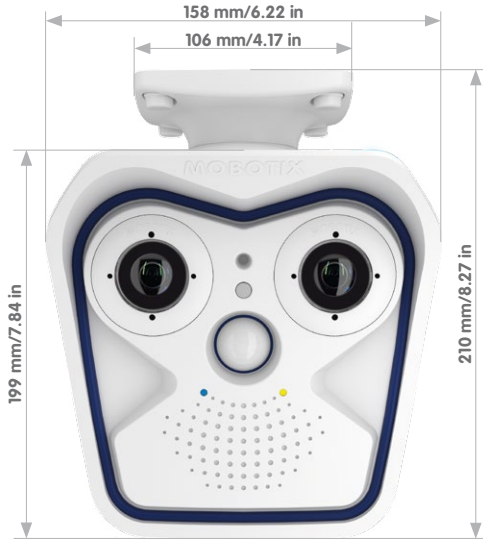

The drilling templates can be found at the end of the manual

Always print or copy drilling template in their original size

1.3.3 L12 Sensor Module



Item	Number	Part Name
2.1	1	Sensor module with affixed washer
2.2	1	L12 lens (installed)
2.3	1	Dome (installed)
2.4	1	Cable retainer with bayonet catch (installed)
2.5	1	Sealing plug, blue, small (installed)
2.6	1	Nut (plastic; not used when installing in M15)

Front View

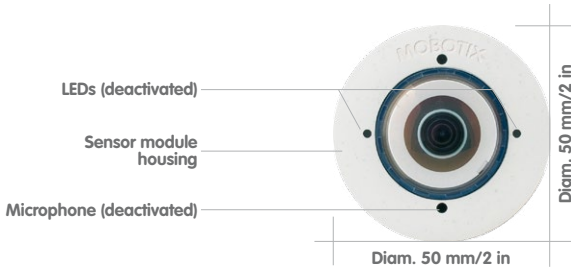

Rear View

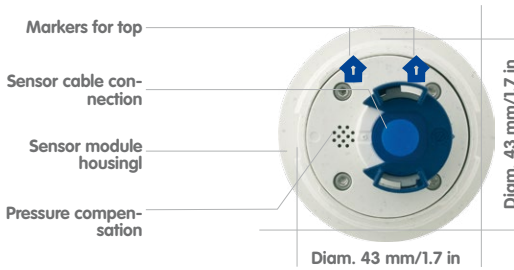

Top = top border of image (North)

Side View

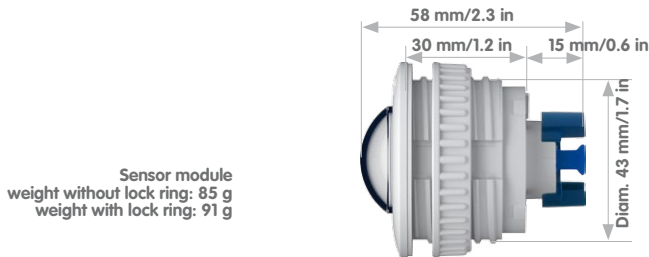

1.3.4 L25, L51 Sensor Modules



Item	Number	Part Name
3.1	1	Sensor module with affixed washer
3.2	1	L25/L51 lens (installed)
3.3	1	Protective glass insert with coated glass (installed)
3.4	1	Cable retainer with bayonet catch (installed)
3.5	1	Sealing plug, blue, small (installed)
3.6	1	Nut (plastic; not used when installing in M15)

Front View

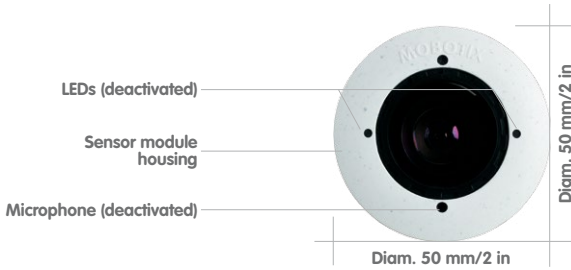

Rear View

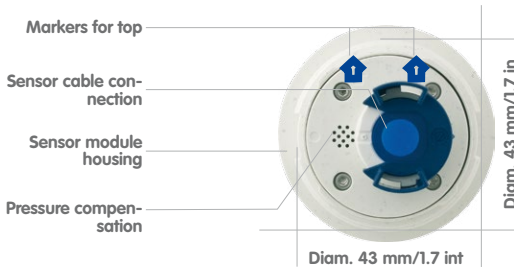

Top = top border of image (North)

Side View

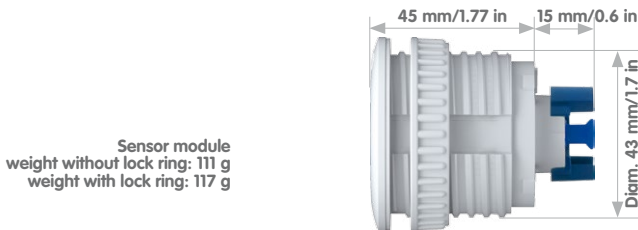

1.3.5 L38, L76, L160 Sensor Modules



Item	Number	Part Name
4.1	1	Sensor module with affixed washer
4.2	1	L38/L76/L160 lens (installed)
4.3	1	Protective glass insert with coated glass (installed)
4.4	1	Cable retainer with bayonet catch (installed)
4.5	1	Sealing plug, blue, small (installed)
4.6	1	Nut (plastic; not used when installing in M15)

Front View

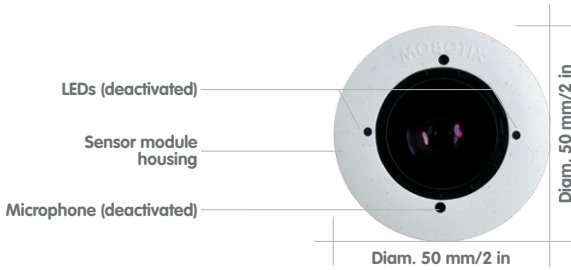

Rear View

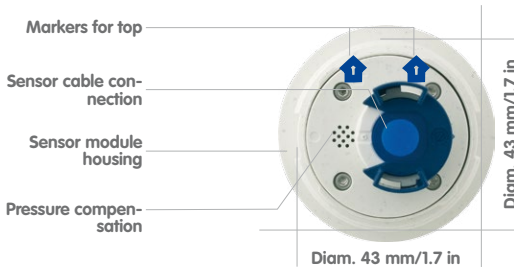

Top = top border of image (North)

Side View

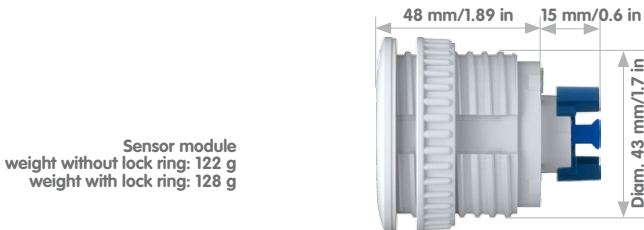

1.3.6 M15D Kits "Day/Night"

In order to facilitate the installation, you also order the M15 as complete kit with one day and one night lens of the same focal lengths.

Available Combinations of Sensor Modules

- D25 – N25
- D38 – N38
- D51 – N51
- D76 – N76
- D160 – N160

Example: M15D Complete Kit With 38 mm Focal Length



Day lens with 38 mm focal length (color)

Night lens with 38 mm focal length (black & white)

MX-M15D-Sec-DNight-D38N38

Advantages of M15D-Thermal Kits

- Weatherproof day/night camera for 24/7 operation with two image sensors.
- Mechanical theft protection of the sensor modules inside the housing, pre-installed at the factory.
- Simplified ordering of an entire M15D with only one order number.
- Environment-friendly, since less packaging is used for shipping the camera.
- Maintains the full flexibility of the M15D platform system, since the camera's sensor modules are easily exchanged against other modules (on-site by the user, for example).

1.4 Available Accessories

1.4.1 Polarization Filter

Order no: MX-SM-OPT-POL

The polarization filter can suppress annoying reflections and thus enhances recognizability of persons behind windshields, for example. This filter replaces the protective glass insert into the corresponding sensor module (note that this filter *cannot* be used in L12 sensor modules). Use the blue lens wrench (M.6) to rotate the polarization filter and to adjust its orientation (see Section 3.3.3, «Inserting A Filter»). Due to its nature, this filter reduces the amount of light that enters the lens by approximately 50 %. The red sealing ring distinguishes this filter from other filters and the protective lens insert.



1.4.2 MiniUSB Cable to MiniUSB (Straight/Angled)

Order no.: MX-CBL-MU-EN-STR-05/2/5 (straight/angled)

MOBOTIX add-on modules (MX-232-IO-Box, ExtIO, CamIO) can be connected directly to the M15 with this cable, which is up to five meters long.



Only cables with angled plugs can be used for the M15

1.4.3 MiniUSB Cable To USB-A Socket

Order no.: MX-CBL-MU-EN-AB-05/2/5

USB-based storage media (for example, USB hard drives) can be connected directly to the M15 with this cable, which is up to five meters long.



1.4.4 Ethernet Patch Cable For Bayonet Catch

Order no.: MX-OPT-CBL-LAN-1/2/5/10
(length: 1 m/2 m/5 m/10 m)

The MOBOTIX-developed special cable can be installed in a waterproof manner and has an integrated sealing gasket. Every M15 ships with a 0.5-m-long cable as standard, which can be exchanged for a patch cable up to 10 m in length.



1.4.5 NPA-PoE-Set

Order no.: MX-NPA-PoE-EU and MX-NPA-PoE-INT (Version EU and Version INT)

Order no.: MX-CBL-NPA-BAT-2 (battery cable for mobile voltage sources)

This is a multi-functional PoE injector according to the IEEE 802.3af standard – with three connectors (for network, camera/PoE device, PC), universal power supply unit with interchangeable adapter plugs and crossover function. The NPA-PoE-Set connects and remotely supplies a M15 with power via an Ethernet cable up to 100 m/328 ft in length. The blue adapter can also be connected to mobile voltage sources from 12 to 57 V DC by means of an additionally available battery cable. The “EU” version of the NPA-PoE-Set is supplied as standard with a European adapter, while the “INT” version includes four adapters (EU, USA, UK, AUS).



1.4.6 MX-Overvoltage-Protection-Box

Order no.: MX-Overvoltage-Protection-Box-RJ45

Order no.: MX-Overvoltage-Protection-Box-LSA

Weatherproof network connector (protection class IP65, –30 to +60°C/–22 to 140°F) **with surge protection of up to 4 kV for MOBOTIX IP cameras**, ideal for replacing the MX-Patch-Box.

At the same time, the MX-Overvoltage-Protection-Box provides a weatherproof connection of a camera's patch cable to a network patch cable (–RJ45 variant) or a network installation cable (–LSA variant).



1.4.7 MX-NPA-Box

Order no.: MX-OPT-NPA1-EXT

The MX-NPA-Box is a weatherproof PoE injector conforming to the IEEE 802.3af standard and is designed to connect to a MOBOTIX camera external voltage sources (12 to 57 V DC).

The MX-NPA-Box is equipped with the Patch-Box's weatherproof and extremely compact exterior housing (protection class IP65, –30 to +60°C/–22 to 140°F), which means it can also be installed in the space of the Outdoor Wall Mount. Interfaces of the MX-NPA-Box: Camera via patch cable, Ethernet via LSA+ and external power supply via terminal connector (12 to 57 V DC possible).



1.4.8 MX-GPS-Box

Order no.: MX-OPT-GPS1-EXT

This box primarily serves as a high-precision time source for systems without an Internet connection. The IT and SEC models additionally provide triggering of GPS-based events (reaching or moving away from a specified position; exceeding or not reaching a specified speed). The MX-GPS-Box can be connected as an add-on module to all MOBOTIX cameras with an MxBus interface.



The MX-GPS-Box is equipped with the same compact housing as the other interface boxes (protection class IP65, -30 to $+60^{\circ}\text{C}/-22$ to 140°F). This interface box should not be installed inside of other wall mounts, but on the exterior of the building with a large section of open sky above it. This ensures the best possible reception from GPS satellites and thereby the highest possible accuracy of the received GPS data. The maximum length of the MxBus wiring (0.8 mm diameter wires) is 50 m/55 yd.

1.4.9 MX-232-IO-Box

Order no.: MX-OPT-RS1-EXT

This box provides the signal inputs and outputs as well as the RS232 (serial) interface. It replaces the connections that were handled on the older camera models via a D-Sub 15-HD connector. The MX-232-IO-Box (protection class IP65, -30 to $+60^{\circ}\text{C}/-22$ to 140°F) can be attached to all MOBOTIX cameras with an MxBus or USB interface. The maximum length of the MxBus wiring (0.8 mm diameter wires) is 50 m/55 yd. If the MiniUSB connector is used, the maximum cable length is 5 m/16 ft.



1.4.10 ExtIO Expansion Module

Order no.: MX-ExtIO

The device, which is suitable both for on-wall and in-wall installations, contains a powerful speaker, microphone, infrared motion sensor, ambient temperature sensor, two input and two output contacts and two illuminated keys. It is ideal for door communication, elevators, access control systems, etc. The ExtIO is suitable for use as direct connection to the M15 via a MiniUSB cable (max. 5 m), which can be ordered separately, or as a network connection via the PoE switch.



1.4.11 Mx2wire+ Media Converter

Order no.: MX-2wirePlus-Set-PW

The Mx2wire+ system allows an Ethernet network with PoE to be set up via two-wire cables, which saves users from having to lay several hundred meters of Ethernet cable. For example, an existing two-wire cable of an analog video camera can be reused to connect a high-resolution and modern IP network camera. Mx2wire+ is delivered in the standard wall outlet frame in different designs; however, it can also be used with the available on-wall socket that is included.



1.4.12 Mounting Interface Boxes Beneath the VarioFlex Wall Mount



Signal input/output
RS232



GPS time and position
information



Ext. power supply
(e.g., solar panel)



Overvoltage protection
+ network connector

If the VarioFlex **wall mount** is used, you can easily install an interface box beneath the foot of the wall mount. Find the drilling template for this task at the end of the manual.

Note that this is not possible when using the **ceiling mount**.



1.4.13 Other Accessories

Since the range of accessories for the MOBOTIX system keeps growing, you should visit the MOBOTIX website www.mobotix.com in the **Products > Accessories** section to see the entire list of available accessories.

THE MOBOTIX INFORMATION CHANNELS



Support on the MOBOTIX Website
www.mobotix.com/other/Support



The MOBOTIX Video Tutorials
www.mobotix.com/other/Support/Tutorials



Seminars on MOBOTIX Campus
www.mobotix.com/other/Partners/Seminars



The MOBOTIX YouTube Channel
www.youtube.com/MOBOTIXAG

1.5 MOBOTIX Software

1.5.1 Integrated Camera Software (Firmware)

MOBOTIX cameras and connected MxBus modules operate with built-in firmware whose functions are accessed by the MOBOTIX remote stations **MxControlCenter**, **MxEasy** and **MOBOTIX App**.

The M15 models therefore also feature a variety of functions that are integrated in the firmware: from motion detection and long-term storage right through to alarm notification via video IP telephony. The virtual PTZ functions allow you to continuously zoom into or out of a MOBOTIX camera image using either the mouse wheel or a joystick.

When recording image or video sequences, you can choose to store either the section of the live image that is visible or the full sensor image (full image storage). This also allows you to examine parts of an image or video that had not been visible in the live image section on display at the time of the recording.

Unlike in the camera systems from other manufacturers, there is no need to buy and install additional software on your computer thanks to the MOBOTIX firmware that can be accessed directly in a web browser via the camera IP address. Instead of using a web browser, you can also download the free **MxControlCenter** or **MxEasy** video management software from the MOBOTIX website (www.mobotix.com > **Support**) to quickly display multiple cameras on one monitor or on an entire video wall, switch alarms with sound or conveniently search for an event. The **MOBOTIX App** for iOS devices (iPhone, iPad, iPad mini, iPod touch) is also available free of charge from the **App Store** for your mobile applications (from Version 5.0).



1.5.2 MxControlCenter

The MxControlCenter video management software can be used to combine any number of cameras at any locations into a well-structured and powerful video security system with centralized or local access-protected operation and analysis.

The state-of-the-art software, specifically tailored to support high-resolution MOBOTIX network cameras, provides a user-friendly user interface and camera image display, convenient video search functions, effective alarm handling, automatic camera integration, video storage on file servers as well as useful configuration and update wizards.

MxControlCenter – Professional Video Management

- Proven worldwide in the most demanding video applications thousands of times over
- Unlimited number of users and cameras, no license fees
- Individual user interface, adaptable to each individual user
- Simple installation and complete use on any standard PC
- Convenient layout editor for integrating real floor plans
- Integration of conventional network and analog cameras as well
- For Microsoft Windows



Several hundred cameras can be managed on a standard PC

Download free of charge from www.mobotix.com

No license fees
Free updates



1.5.3 MxEasy

MxEasy makes it simple to operate the most important functions of the camera thanks to its intuitive user interface and represents a new approach to viewing and controlling MOBOTIX cameras. The clear design allows you to manage up to 16 cameras, and the application can show up to four cameras at the same time.

All settings selected in MxEasy (for example, virtual camera position, zoom, brightness, volume, microphone sensitivity, image storage, signal outputs) can be used immediately and are stored instantly in the configuration of the corresponding camera. The calendar functions integrated in the Alarm Planner provide an innovative tool for the scheduled settings of one or more cameras. This tool not only controls video and sound recording based on certain time and date information, but also allows features like video motion detection, image brightness and the microphone to be activated/deactivated based on a date and time schedule.

MxEasy – Simple Operation Of The Most Important Camera Functions:

- Cameras can be installed without any knowledge of networks
- Supports up to 16 MOBOTIX cameras
- Time- or event-controlled recording
- Time-controlled motion detection, image brightness and microphone
- For Microsoft Windows and Mac OS X

Suitable for up to 16
MOBOTIX cameras

Download free of charge
from www.mobotix.com

No license fees
Free updates



1.5.4 MOBOTIX App

Premium solution: There for you whenever and wherever you need it, the MOBOTIX App serves as the perfect mobile remote station that uses intelligent detailed solutions to increase security and convenience for users on a daily basis. The controls are optimized for use with touchscreen devices and feature three main views (Live, Player, Events), self-explanatory symbols, large softbuttons, multifunctional sliders developed by MOBOTIX as well as simple gestures like swipe and tap, making it easy for newcomers and older users to work with professional security equipment. In addition, using mobile devices to operate the various functions such as door opening, activating the voice mailbox, switching the door bell off at night and switching a light on/off, creates added value in the form of greater convenience and security in every day life.

MOBOTIX App – Mobile Remote Station For MOBOTIX Cameras And Door Stations

- Bandwidth-optimized remote access via WLAN (Wi-Fi) or the Internet
- Live images and recordings in the best MOBOTIX HiRes quality
- Two-way communication, door opening and video mailbox access
- Doorbell and alarm notifications, protection of privacy
- Convenient search functions, playback of external MxPEG videos
- Grouping of cameras and filtering of events
- Free from the **App Store** for the iPad, iPad mini, iPhone and iPod touch



Free download from the **App Store**

No license fees
Free updates



2 INSTALLATION

The MOBOTIX M15 has been designed to be mounted on walls and ceilings. It can also be installed on a mounting pole using the appropriate MOBOTIX accessories. The different installation options are described in *Section 2.3, «Mounting The Camera With Wall Mount»* and the following sections, while the drilling templates are included at the end of the manual.

2.1 Preparing The Installation

Before installing the MOBOTIX M15, the following questions should be answered:

1. Where will the camera be installed?
2. What other additional installation options are available?
3. How is the camera connected to the network and how is the power supplied?
4. How are the connections furnished from the building?
5. What cabling considerations are necessary?

The following sections in this chapter should answer all these questions. If anything is unclear or you have more questions, please contact your MOBOTIX partner or MOBOTIX Support directly. Contact information can be found at www.mobotix.com under **Support**.

2.1.1 Installation Options: Wall, Ceiling, Pole

Like all MOBOTIX cameras, the **M15 is extremely flexible** in terms of how and where it can be installed. An M15 can be used for both indoor and outdoor applications: in fixed or mobile applications – constantly changing locations or in/on vehicles of any kind. The M15 cameras have been certified **weatherproof according to IP66 IP66** and can work reliably in temperature ranges from -30 to $+60^{\circ}\text{C}/-22$ to $+140^{\circ}\text{F}$ without heating or fan. A practical weather and sun protective cover is integrated into the extremely resistant housing, which is made of UV-resistant special-purpose plastic.

Thanks to the camera's unique VarioFlex mounting system (supplied as standard), the M15 camera can be installed quickly and easily on any wall, ceiling or even a round pole of up to 18 cm in diameter (when combined with the stainless steel pole mount). The VarioFlex mounting system allows a wide range in both the horizontal and vertical directions (rotating and tilting) to enable precise adjustment to suit the area to be monitored. **The mount also fits directly over in-wall sockets (without the frame) and MOBOTIX interface boxes** to fully conceal the cable, thus improving the security of the installation.

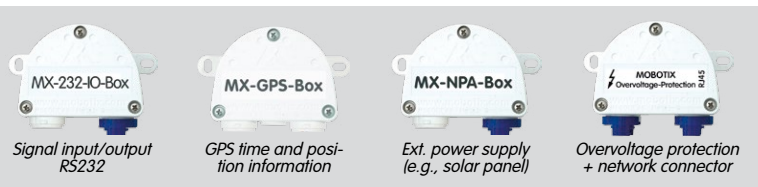



Tilting the camera when installed on a wall

- Horizontal: 180°
- Vertical: -60° to +20°

Tilting the camera when installed on a ceiling

- Horizontal: 360°
- Vertical: -90° to +17°

The VarioFlex mount consists of a central joint, which is directly screwed into place with the M15 housing, and a wall and ceiling mount, which is fastened to the central joint with just one screw. In addition to being easy to install, the VarioFlex mount enjoys the advantage of featuring **completely concealed cabling** and high impermeability to water and dust (IP66). Wall and ceiling mounts are designed such that they can be installed over conventional in-wall sockets (without the frame) or cavity sockets and conceal them completely. A MOBOTIX interface box can be integrated in the wall mount.

Space for RJ45 in-wall socket/concealed cabling



VarioFlex wall mount with protected cabling and cover for in-wall sockets and MOBOTIX interface boxes

Make sure that you have found the best camera position before installing the camera. It is important that the camera's field of view is not obstructed in any way. Once the camera has been installed on a wall or ceiling, you can fine-tune its position. If the monitored area changes or the camera has to be installed in a different location, it is easy to exchange the camera's sensor modules and continue using the camera, without having to upgrade to new video software.

Wall Installation

The M15 can be installed on the wall of a building or structures, even mobile surfaces, for both indoor and outdoor use. The camera is mounted using the pre-installed **VarioFlex mount (supplied as standard)**, which is easily secured using the four enclosed screws and screw anchors (depending on the surface, it can also be mounted without screw anchors directly over the in-wall socket). The Ethernet connection cable of the camera has already been guided through the mount and simply needs to be connected with the network cable on-site (for example, using the MX-Patch-Box). By adjusting the VarioFlex mount as required, the captured image area can be precisely adjusted to the desired practical application. **The camera can be turned or tilted 180° horizontally and 80° vertically (from -60° to +20°).**

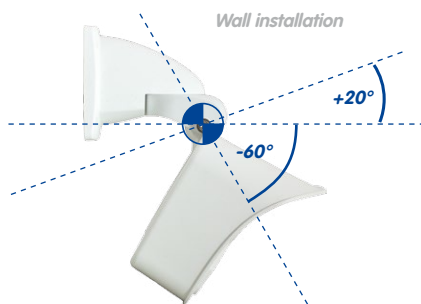

Wall installation

- Horizontal: 180°
- Vertical: -60° to +20°

Ceiling Installation

By exchanging the wall mount for the separately supplied ceiling mount, the M15 is ready to be **installed on ceilings in just a few easy steps** thanks to the VarioFlex system. This installation option is of particular benefit when monitoring rectangular rooms with a single camera. In such cases, the L25 sensor module with Super Wide-Angle lens allows the room to be monitored almost entirely by an M15 installed on the ceiling in one of the corners. Using the PTZ software, you can easily zoom in on image details in either the live image or the recording. **The camera can be turned or tilted 360° horizontally and 107° vertically (from -90° to +17°).**



Installing On A Pole (With Accessories)

Installation on round poles is frequently used for cameras that are intended for mobile outdoor use (for example, surveillance of construction sites). For this purpose, MOBOTIX recommends using the pole mount, which is available for the M15 as an accessory and is almost indestructible (MX-MH-SecureFlex-ESWS). This pole mount is made from rust-proof stainless steel with a white coating and is used in combination with the pre-installed VarioFlex mount supplied as standard with the wall mount.

Poles with a diameter between 60 and 180 mm can be used. It is particularly advisable to use cavity (metal) poles, in which the network cable is not visible and can be protected from attacks. For more detailed information on the installation process, see *Section 2.2, «First Installation Steps»*. The drilling templates are at the end of the manual.

2.1.2 Installing The Camera With Hemispheric Sensor Modules

The camera must be correctly positioned on the wall or ceiling in order to be able to use the high-resolution hemispheric image display options of the M15 with L12 sensor module(s). The entire hemisphere of the room in front of the camera is then effectively monitored.

High-Resolution Panorama Images

The M15 with L12 sensor module(s) is primarily suited to providing an excellent **overview in the form of a high-resolution panorama image**, and less suitable for more exact details. For active operation, the camera should be installed at an (out of direct reach) **height ranging from 2.5 m to 3.5 m**. People, for example, may be **identified very well at distances of up to 1.5 m** and **with sufficient detail at up to 3 m**. Objects can be detected even at distances of **5 m and more from the camera**. During installation, ensure that the camera is focused on the most important areas of the room as directly as possible in order to optimize image quality and provide the desired level of detail recognition. This applies above all to wall and ceiling installations that must be carried out at greater heights for technical or other reasons (over doors, windows, etc.). The lens capabilities can be only fully utilized by tilting the camera appropriately.



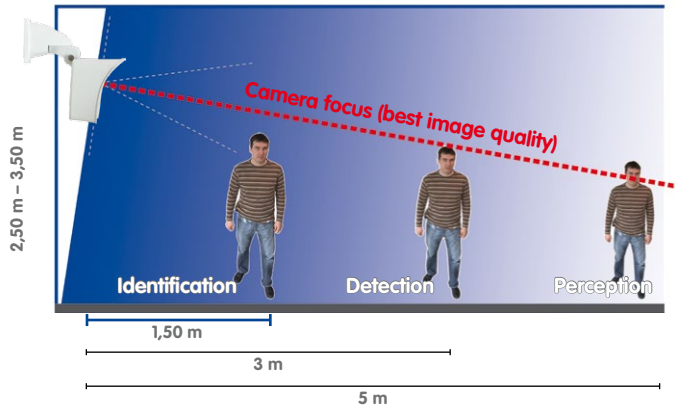

MOBOTIX recommendation



MOBOTIX original 180° Panorama image (L12 sensor module)

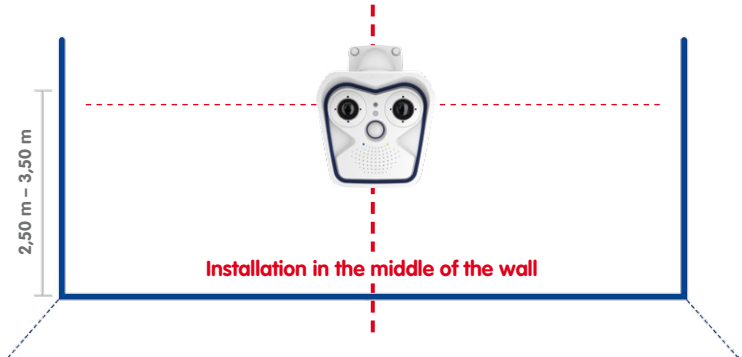

Allround View

A single M15 sensor module can monitor an entire room right into each of the four corners (360° Panorama View) thanks to its hemispheric lens. The camera should ideally be positioned on the ceiling in the center of the room. Rooms with a square floor area of up to approx. 40 m² generally allow the recognition of detail even at the borders of the full image. Rooms with up to 100 m² of floor area can be monitored using one single camera if you only want to monitor specific objects or to know if persons enter a room.

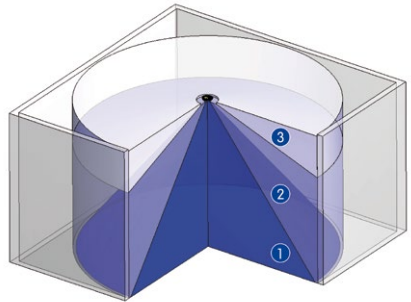

The **image quality** (precision) diminishes as the distance of an object to the camera focus point increases: 1 very good, 2 good, 3 satisfactory

Capture of entire room

Furthermore, the "camera view from top to bottom" can also be achieved by installing the camera on a wall or a pole at a tilt of 90°.

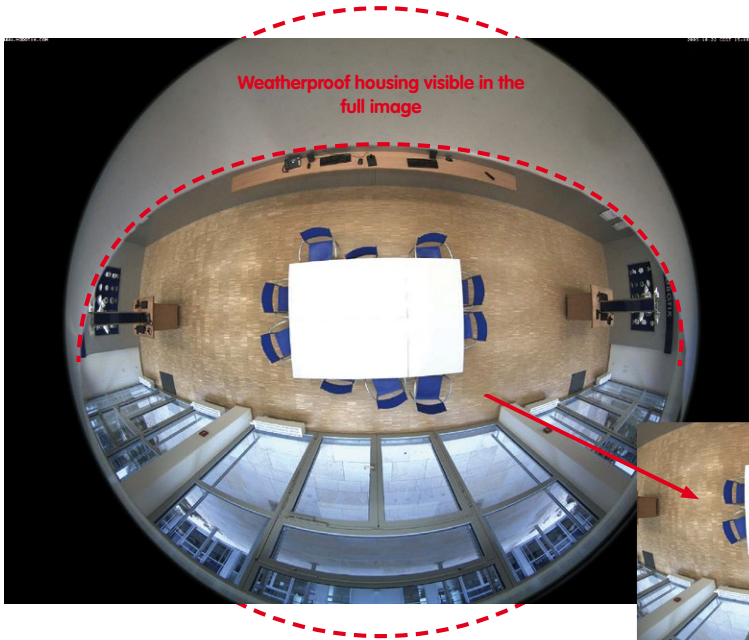

Panning/tilting/zooming removes the area concealed by the weatherproof cover

Note

Part of the captured image area is concealed behind the protective cover of the M15 housing, especially in the full image. For this reason, M15 cameras with L12 lens should be adjusted so that the concealed areas are not those that are supposed to be monitored. The concealed area can be completely removed from the image by panning/tilting/zooming the image using the virtual PTZ function.

The M15 supports Power-over-Ethernet according to IEEE 802.3af (PoE)

The PoE adapter replaces the crossover cable when directly connecting to a computer



2.1.3 Network Connection And Power Supply, UPS

Power-Over-Ethernet (PoE Conforming To IEEE 802.3af)

All M15 models are supplied with power using the PoE standard. The PoE Adapter Set (MX-NPA-PoE-Set) may be used for smaller installations, or the weatherproof PoE injector MX-NPA-Box (MX-OPT-NPA1-EXT) may be used in outdoor scenarios. For larger installations, we recommend investing in a PoE-capable supply device available on the market. **Section 2.7 contains more information on the possible combinations of connecting the M15 and power supply options.**

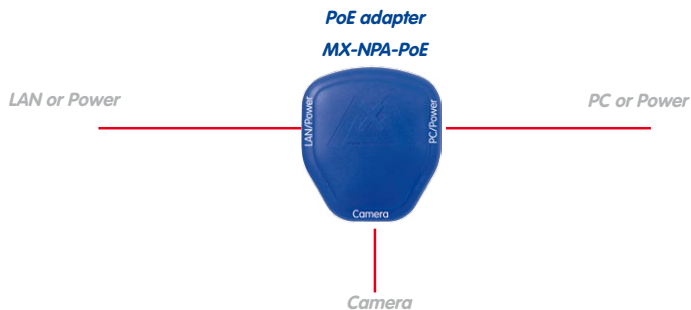

The **maximum length** of the network cable for power supply over an Ethernet cable is **100 m**. The Mx2wire+ media converter set (available as an accessory) can be used to extend the range of an Ethernet connection up to 500 m in length (maximum transmission speed for a 500-m cable: 45 Mbps and 12 W for the PoE device).

Note

The MOBOTIX M15 can be powered by switches or routers that support the PoE (Power-over-Ethernet) standard and conform to IEEE 802.3af.

Advantages of PoE power supply:

- Centralized backup power supply available via network
- Lower, more cost-effective power consumption
- Camera does not require an additional network connection

Using Uninterruptible Power Supplies (UPS)

You should install an uninterruptible power supply (UPS) in order to maintain a continuous power supply even when utility power fails. These devices also provide full protection against electrical surges and voltage fluctuations, enhancing the reliability of the system as a whole.

When using a more powerful 19" rack-mounted UPS, you can also protect all other network components (for example, switches, routers, PoE switches, etc.).

Since MOBOTIX cameras do not require any heating, even during winter, the average power consumption of less than 5 watts is very low. This, in turn, means that you can centralize the UPS-protected power supply by injecting power into the Ethernet cables (max. 100 m). This kind of protected power supply can be used either with MOBOTIX PoE products (MX-NPA-PoE + Universal Power Supply) or with PoE-compliant switches according to IEEE 802.3af.



2.1.4 Providing the Camera Connections, MX-Overvoltage-Protection-Box

Once the camera position, the position of the cable outlets and the method of power supply have been decided upon, the cabling can be installed. Before installing the MOBOTIX M15, you should make sure that the network connections have been thoroughly tested so that the proper functioning of the camera is guaranteed.

If the camera is to be installed outdoors, you should also install the MOBOTIX MX-Overvoltage-Protection-Box (optional accessory). This interface box not only provides **overvoltage protection of up to 4 kV for MOBOTIX IP cameras**, it also provides simple and weatherproof connection of the cameras to a network patch cable (-RJ45 variant) or a network installation cable (-LSA variant).

For additional information on the MX-Overvoltage-Protection-Box, open the **Products > Accessories > Interface Boxes** section on www.mobotix.com.

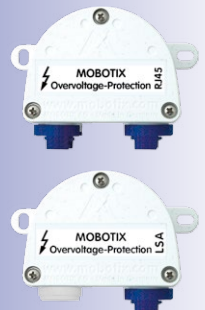

UPS units not only protect the camera against power failures, they also protect all other connected network devices against damage from voltage peaks and lows

2.1.5 Wiring, Fire Prevention, Lightning And Surge Protection

When installing the wiring inside or outside of buildings, make sure you always adhere to the relevant regulations on wiring, fire prevention, and protection against lightning.

MOBOTIX cameras are protected against the effects of small electrical surges by a range of measures. These measures, however, cannot prevent the camera from being damaged when stronger electrical surges occur. Particular care should be taken when installing the camera outside to ensure proper **protection against lightning**, as this also protects the building and the entire network infrastructure.

MOBOTIX recommends having MOBOTIX cameras installed only by certified specialists accustomed to installing network devices and having proper respect for the applicable regulations regarding lightning protection and fire prevention as well as the current technology for preventing damages from electrical surges.

Wiring

When installing the wiring, make sure to follow these guidelines:

- **Data cable:** Make sure you only use double-shielded Cat 5 or higher cable (**S/STP**) for Ethernet connections.
- **Outdoors:** Installing the camera outdoors requires special precautions and measures regarding the cables as well as lightning and surge protection.
- **Wire lengths:** The cable segments must not exceed the maximum allowed cable lengths in order to ensure proper data transfer.
- **Avoiding induction:** When running data cables parallel to existing regular power lines or high-voltage wires, make sure you observe the minimum distances to the power cables.



Fire Prevention

When installing the power lines to the camera, make sure you always adhere to the country-specific regulations (for example, VDE in Germany, IEEE in the U.S.) in effect on wiring and fire prevention at the site of the installation.

Lightning And Surge Protection

In order to avoid damage to MOBOTIX cameras from overvoltages, you should always install the MX-Overvoltage-Protection-Box. This competitively priced and weatherproof network connector provides reliable protection against overvoltages of up to 4 kV; the box is easily installed in the Outdoor Wall Mount, for example (see *Section 1.4.6, «MX-Overvoltage-Protection-Box»*).



2.2 First Installation Steps

2.2.1 Initial Installation of the Sensor Modules (except M15D-Sets)

The MOBOTIX M15 cameras are delivered with a pre-assembled housing as **M15 Core** camera. The sensor modules (consisting of lens carrier, image sensor and lens) need be ordered separately. Upon delivery, the sensor module sockets in the front element are fitted with transport plugs. When operating the camera, it needs to be fitted either with sensor or blind modules. This closes off the front element and protects the camera against foreign objects, insects and water.

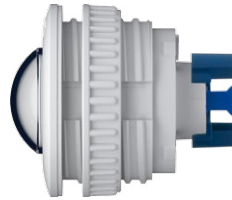

L12 sensor module

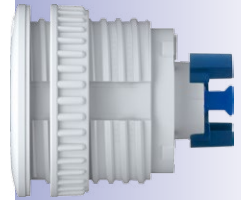

L25, L38, L51, L76, L160 sensor modules

Not required with M15D Kit (see Section 1.3.6)

Caution

Only replace the sensor modules when the camera is disconnected from the power supply. Make sure the power supply to the camera is disconnected before installing or replacing sensor modules.

When installing the sensor modules, make sure that the sensor module cables and the patch cable are not damaged or bent sharply.

Using One or Two Sensor Modules

With an M15, you have the choice of using the camera with one or two sensor modules. Since the modules are easily exchanged, it is also possible to add a module or to use different ones later on.



MOBOTIX Tutorials:
<http://www.mobotix.com/other/Support/Tutorials/>

Caution

Note that you must not operate the M15 with installed transport plugs, since the camera is not protected against the environments:



M15 with two transport plugs:
No operation allowed!



M15 with one transport plug:
No operation allowed!



M15 with one blind module:
Unrestricted operation (IP66)



Transport plug



Procedure

1. **Prepare the sensor module:** Remove the plastic lock nut (this is not needed any more). Remove the bayonet catch by rotating it counter-clockwise, then remove the blue rubber plug.

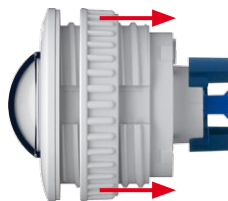

2. **Remove the transport plugs:** Gently pull the two transport plugs out of the sensor module sockets by lifting the rim of the plugs. Now pull the connectors of the sensor module cables out of the back of the transport plugs; take care not to damage the connectors or the cables. **Make sure that you do not pull the sensor module cables out of the housing!**



3. **Connect sensor module cable:** Firmly push the sensor module cable into the module's connector as shown in the figure.



4. **Lock sensor module cable:** Apply bayonet catch as shown and turn it clockwise until it gently snaps shut.



5. **Insert the sensor module:** Make sure that the MOBOTIX lettering on the sensor module is at the "9 o'clock" position as shown in the figure.



6. **Lock the sensor module:** Using the black module wrench, turn the sensor module clockwise until it stops.



Repeat steps 3 to 6 for the second sensor module or the blind module, respectively. **Installing the blind module is a mandatory prerequisite when using the M15 as a mono camera with only one sensor module.**



Blind module

Caution

Note that the sensor modules are not yet protected against theft and unwanted rotation (e.g., due to vibration). In such a case, it is **highly recommended to install the security clips (M.11):**

- Section 2.2.2, «Opening the Camera Housing»
- Section 2.2.3, «Installing the Security Clips (Optional, Not Required for M15D-Sets)»
- Section 2.2.8, «Closing the Camera Housing»



2.2.2 Opening the Camera Housing

The following tasks require opening the camera housing and removing the front element of the M15 in order to get to the interior of the M15:

- Inserting security clips at the sensor module or the blind module, respectively.
- Exchanging the MOBOTIX Ethernet patch cable against a longer MOBOTIX patch cable.
- Connecting an MxBus two-wire cable in order to attach MxBus extension modules (e.g., the «MX-GPS-Box»).
- Connecting a MOBOTIX USB cable in order to attach external data storage devices or an «MX-232-IO-Box».
- Exchanging the pre-installed SD card (4 GB) against a larger one or as preventive maintenance measure (see Section 3.5, «MicroSD Card Recording»).



Procedure

1. Place the camera face-down on a clean and dry surface.
2. Remove the two rubber plugs at the back of the camera housing.
3. Using the supplied 5 mm Allen wrench, loosen the two bolts at the back of the camera housing. Leave the bolts and washers in the camera housing.



4. Using the Allen wrench, **cautiously** push from behind **in an alternating fashion** onto the left and the right bolt (red arrow in upper figure) and push the front element out of the front of the housing.
5. Tilt the front element forward as shown in the figure.

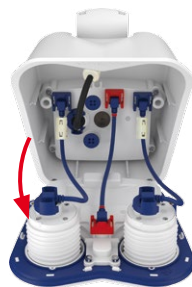

Remove rubber plugs at the back of the housing using small screwdriver

Not required with M15D Kit (see Section 1.3.6)

2.2.3 Installing the Security Clips (Optional, Not Required for M15D-Sets)

The security clips are protecting the sensor modules or the blind module in the front element of the M15 against unwanted rotation (e.g., due to vibration when mounted on a pole or in an automotive scenario).

**Procedure**

1. **Open camera housing:** Open the camera housing as described in Section 2.2.2.
2. **Insert the security clips:** To protect the modules against unwanted rotation insert the two red security clips at the insides of the sensor modules (as shown in the figure). Make sure that the security clips click into place as shown in the image detail.
3. **Close camera housing:** Close the camera housing as described in Section 2.2.8.

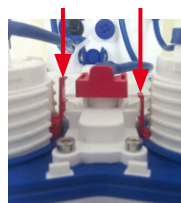

2.2.4 Exchanging Sensor Modules

Note that you only need to follow this procedure if the security clips (M11) have been installed. Since the sensor modules cannot be exchanged from the outside in such a case, you need to remove the front element, replace the sensor modules and install the front element again. If no security clips have been installed, you can exchange the sensor modules as described in Section 2.2.1, «Initial Installation of the Sensor Modules (except M15D-Sets)».

Procedure

1. **Open camera housing:** Open the camera housing as described in Section 2.2.2.
2. **Remove the security clips:** The sensor or blind modules may have been protected against unwanted rotation by applying the security clips. Push the top of the security clip in the direction of the blue arrow (see figure in the side note) so that it can pass the notch and pull the clip upwards.

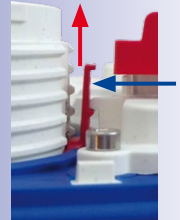
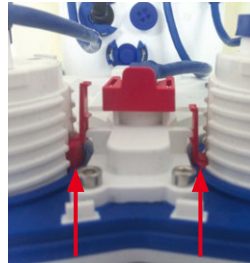

3. **Remove the sensor module cable from the sensor or blind module:** The sensor module cables are secured using a special cable lock with bayonet catch. To remove the bayonet catch turn it counter-clockwise until it gently snaps open. Take off the catch and pull out the cable.



4. **Remove the sensor or blind module:** Set the black module wrench onto the sensor or blind module, so that the two notches lock into the two holes of the module (at the 12 and 6 o'clock positions). Turn module wrench counter-clockwise by 90 degrees until it stops.



Push the sensor or blind module out of its socket.

5. **Prepare the new sensor module:** Remove the plastic lock nut (this is not needed any more). Remove the bayonet catch by rotating it counter-clockwise, then remove the blue rubber plug.

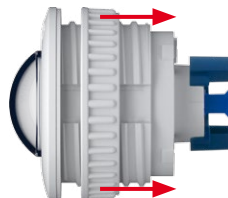

6. **Connect the sensor module cable to the sensor module:** Guide the cable through the opening in the front element and firmly push the sensor module cable into the connector. Apply bayonet catch as shown and turn it clockwise until it snaps shut.



7. **Insert the sensor module:** Make sure that the MOBOTIX lettering on the sensor module is at the "9 o'clock" position as shown in the figure. Using the black module wrench, turn the sensor module clockwise until it stops.

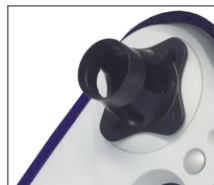

8. **Insert the security clips:** To protect the modules against unwanted rotation insert the two red security clips at the insides of the sensor modules (as shown in the figure). Make sure that the security clips click into place as shown in the image detail.

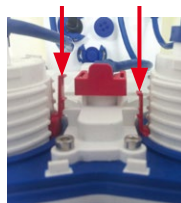

9. **Close camera housing:** Close the camera housing as described in Section 2.2.8.

2.2.5 Replacing the Ethernet Patch Cable

If you want to replace the pre-installed MOBOTIX patch cable (0.5 m/20 in) by a longer one, make sure that you only use genuine MOBOTIX cables (see Section 1.4.4, «Ethernet Patch Cable For Bayonet Catch»).

Procedure

1. **Open camera housing:** Open the camera housing as described in Section 2.2.2.
2. **Remove the patch cable:** Turn the bayonet catch of the patch cable at the inner housing cover (red circle in figure) counter-clockwise and remove the catch.

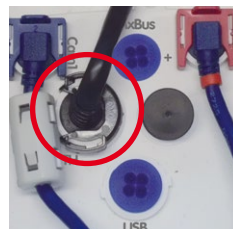

3. **Remove hinged ferrite and pull out cable:** Remove the hinged ferrite from the patch cable by cautiously opening the two latches with a small screw driver. Gently pull the patch cable out of the housing (you may have to remove the foot of the wall mount to be able to do this).



4. **Attach ferrite at the new patch cable:** Attach the hinged ferrite at the new patch cable, leaving a space of exactly 70 mm/2.8 in between the sealing of the plug and the ferrite.

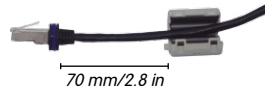

5. **Guide the patch cable into the housing:** Guide the new cable from the front through the cable guide in the hinge of the VarioFlex mount (see figure). Reinstall the foot of the wall mount if you removed it in step 3.

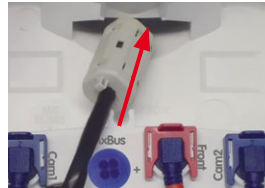

6. **Connect the patch cable:** Insert the plug of the Ethernet cable into the appropriate connector. Apply bayonet catch as shown and turn it clockwise until it gently snaps shut.

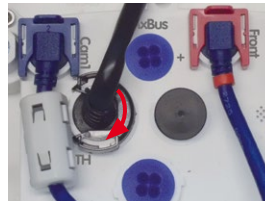

7. Make sure that the hinged ferrite rests between the inner housing cover and the cable guide at the top of the housing as shown.

8. **Close camera housing:** Close the camera housing as described in *Section 2.2.8*.

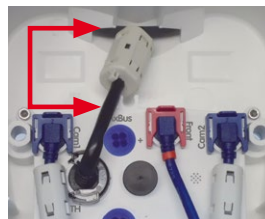

In order to ensure the weatherproofness of the M15, make sure that you only use genuine MOBOTIX patch cables!



2.2.6 Connecting a USB Cable

Using the USB plug (red circle in figure), you can attach existing expansion modules, such as the MOBOTIX ExtIO (USB), the MX-232-IO-Box or external USB hard drives to the camera in a weatherproof and well-protected manner.

Procedure

1. **Open camera housing:** Open the camera housing as described in *Section 2.2.2*.
2. **Remove the single wire plug:** Remove the blue single wire plug (red circle in figure).



3. **Guide the USB cable through the housing:** Guide the cable from the front through the cable guide in the hinge of the VarioFlex mount (see figure).

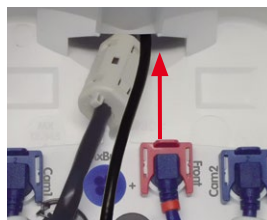

4. **Connect the USB cable:** Insert the MiniUSB plug into the appropriate connector. Apply bayonet catch as shown and turn it clockwise until it gently snaps shut.
5. **Close camera housing:** Close the camera housing as described in *Section 2.2.8*.

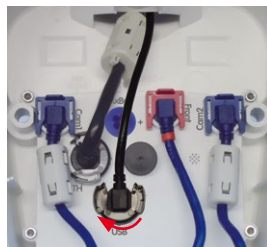

Only use USB cables with angled plugs inside the housing of the M15!



2.2.7 Connecting a Two-Wire MxBus Cable

You can use such a cable to connect additional MOBOTIX modules (e.g., the MX-GPS-Box or the MX-232-IO-Box) to the M15.

Note that you can attach two MxBus cables (each having two wires) to the MxBus connector (red circle in figure). Take care not to switch the polarity of the wires. It is recommended to use the same wire color for +/- for the entire MxBus system (e.g., red = +, blue = -).

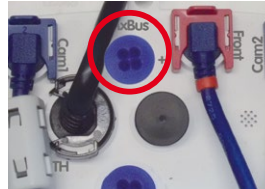

The length of the entire MxBus wiring must not exceed 50 m/55 yd.

Procedure

1. **Open camera housing:** Open the camera housing as described in Section 2.2.2.
2. **Prepare the MxBus wires:** Remove the blue single wire plug. Strip 5 mm (1/5 in) of insulation from the wire ends, then push each wire into one of the four holes in the single wire plug (this prevents humidity from entering the camera).
3. **Connect MxBus wires:** Push back the blue single wire plug so that you can easily attach the MxBus wires. Attach the MxBus wires by firmly pushing the wires into the corresponding connectors. Carefully press the single wire plug into the connector socket and twist the MxBus wire pairs.

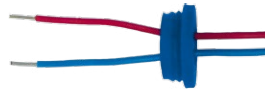

Single-wire plug

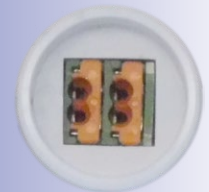

MxBus connector

If you need to remove one of the wires, you need to unlock the connector by pressing on the orange-colored area using a small screwdriver, then pull out the wire.



4. **Guide the MxBus cable out of the housing:** Guide the cable from the front through the cable guide in the hinge of the VarioFlex mount (see figure).
5. **Close camera housing:** Close the camera housing as described in Section 2.2.8.

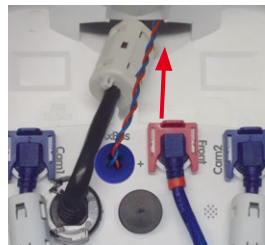

Notes

After you have connected an MxBus module, you need to activate it in the camera's browser interface (**Admin Menu > Manage Hardware Expansions** or **Manage MxBus Modules**, respectively).

2.2.8 Closing the Camera Housing

Once you have completed the tasks in the interior of the M15, you need to reassemble the front element of the M15. Make sure that you are reconnecting all plugs as shown in the figure if you removed any of them:

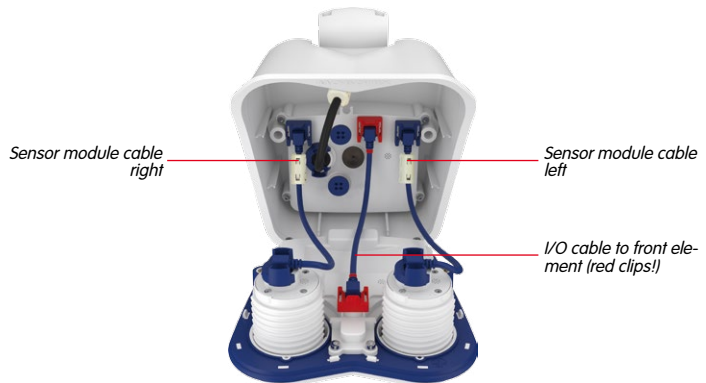

Procedure

1. Before inserting the front element, make sure that the sensor module cables of both image sensors are running at the **inside** of the screw bore (see red arrow). **The sensor cables must not run along the outside of the screw bores (see figure below)!**



- 2. Place the camera on its right side (as seen by the camera) as shown. Push the cable of the left sensor module under the retaining lug at the screw bore (red circle in detail figure)



Caution

When inserting the front element, the sensor cables must not come between the guides at the side of the housing, since this will destroy the cables!



- 3. Push the front element into the housing and make sure that the sensor module cable remains under the retaining lug (red circle in detail image).

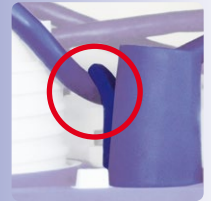
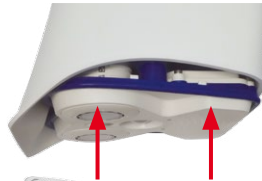

- 4. Continue to push the front element into the housing, then evenly press the front element into the housing at the spots indicated by the red arrows.



- 5. Using the supplied 5 mm Allen wrench, tighten the two bolts at the back of the camera housing. Push the two rubber plugs back into the opening of the screws to prevent humidity and dirt from entering the camera.



Do not forget to apply rubber plugs at the back of the housing!

2.3 Mounting The Camera With Wall Mount



The M15 is an allround camera designed for use in indoor and outdoor applications. The camera must always be installed with the VarioFlex mount, which has been prepared at the factory for wall mounting and allows the cabling to be concealed. The best camera position for the selected lens must be found before installing the camera on the wall (see Section 2.1.1, «Installation Options: Wall, Ceiling, Pole» and Section 2.1.2, «Installing The Camera With Hemispheric Sensor Modules»). You can fine-tune its position once the camera has been installed on the wall.

2.3.1 VarioFlex Wall Mount

Using the VarioFlex wall mount, the camera can be precisely panned, both **horizontally and vertically**, to suit the area that is to be monitored.

When installed on a wall, the camera can be turned or tilted as follows:

- horizontally: 180°
- vertically: 80°

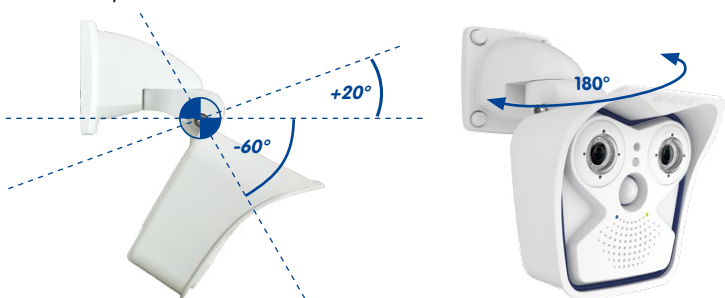

Tilting the camera when

installed on a wall:

• Horizontal: 180°

• Vertical: 80°

Mounting The Camera With Wall Mount

In order to ensure a flush finish with the surface, connect the camera patch cable to the **network cable using a standard adapter** that is protected in the wall mount or a **MX-Patch-Box** that can easily be inserted into the cavity socket of the wall mount (VarioFlex mount). For more information on the MX-Patch-Box, please visit www.mobotix.com and go to the **Products > Accessories > Interface Boxes** section. It is also possible to **install an in-wall socket with RJ45 connector**. When doing so, make sure that the in-wall socket is placed as high up in the wall mount housing as possible.

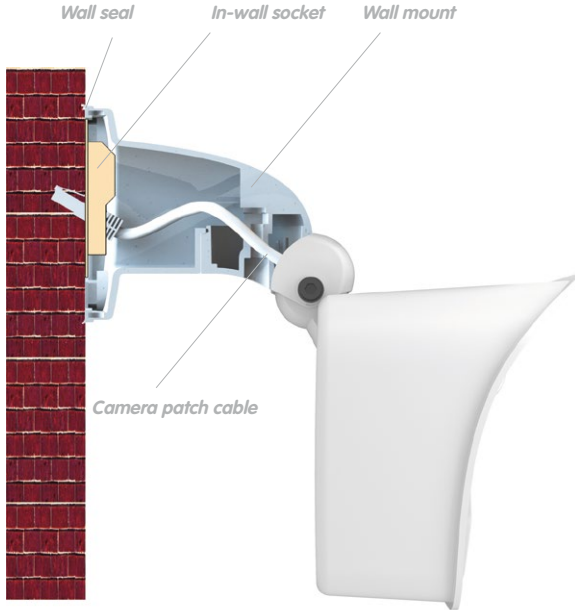

When installing **on-wall cabling**, breaking out one of the four possible openings in the base of the wall mount with a pliers will ensure that the cables can be fed neatly into the camera. The connection to the camera patch cable can be established using a suitable adapter within the wall mount.

Caution: If using the camera outdoors, only use the opening at the bottom of the mount to prevent water from entering the mount!



MX-Patch-Box in the wall mount



Pliers to break through a cable guide



Procedure

1. **Install and prepare the network connection:** The pre-installed patch cable attached to the camera must be connected with the on-site network cable. The connection can either be established using an installed in-wall socket with RJ45 connector or, in the case of a protruding network or patch cable, using the MX-Patch-Box. In both cases, the connection is well protected and is neither accessible nor visible from the outside.



No screw anchors are required for wooden surfaces

2. **Drill the holes:** Use the supplied drilling template for the camera (found at the end of the manual or, if used, the extended drilling template included in the MX-Patch-Box package). Drill the holes for the supplied screw anchors. Screw anchors do not have to be fitted if the surface is made of wood. To secure the mount, the supplied stainless steel hex head screws will be screwed directly into the surface later on. You should start with a 2-mm drill bit, for example (drilling depth just slightly less than screw length), in order to facilitate screwing in wood.

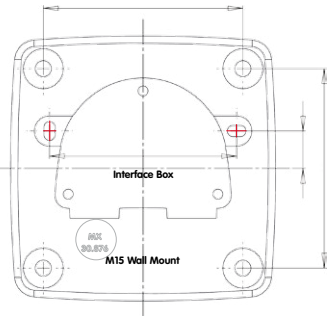

3. **Attach wall seal:** Place the white rubber sealing ring with the groove on the edge of the wall mount.



Additional sealing possible, for example, with shrink tubing

4. **Connect the cable:** Connect the on-site network cable to the camera patch cable using an adapter or insert the patch cable into the RJ45 outlet. Take note of the installation manual included in the package when using a MX-Patch-Box. All manuals can be downloaded and printed (as PDF files) from the MOBOTIX website (www.mobotix.com) in the **Support > Manuals** section. Make sure that the cables are not bent or squashed.



- 5. Mount the camera:** Place the wall mount over the drill holes and hold it against the wall. Then use the four screws each with a washer and tighten them using the appropriate wrench. Do not overtighten the screws as this may damage the plastic mount. Check that the screws are securely in place and place the white caps on the screw heads. Then aim the camera as described in *Section 3.3*.



- 6. Clean sensor modules:** Clean the protective glass and the dome of the sensor modules with a clean soft cotton cloth for optimal image results.



- 7. Establish a connection to the camera, check the image:** Establish a connection to the camera as described in *Section 3.1, «Manual and Automatic Operation – Overview»* and the following sections. The live image from the camera should be visible on the computer monitor. Check image sections on the computer monitor.



Screw caps for lock screws

Note

The **VarioFlex mount** and **ceiling mount** must always be used for **ceiling installation** (see *Section «Ceiling Installation»*).

2.4 Mounting The Camera With Ceiling Mount



The M15 is an allround camera designed for use in indoor and outdoor applications. The camera is always installed together with the VarioFlex mount, which is shipped as a wall mount, but can be converted to a ceiling mount in just a few steps. The best camera position for the selected lens must be found before installing the camera on a ceiling, an overhang or balcony (see Section 2.1.1, «Installation Options: Wall, Ceiling, Pole» and Section 2.1.2, «Installing The Camera With Hemispheric Sensor Modules»). You can fine-tune its position once the camera has been installed on the ceiling.

2.4.1 VarioFlex Ceiling Mount

Using the VarioFlex ceiling mount, the camera can be precisely panned, both **horizontally and vertically**, to suit the area that is to be monitored.

When installed on a ceiling, the camera can be turned or tilted as follows:

- horizontally: 360°
- vertically: 107°

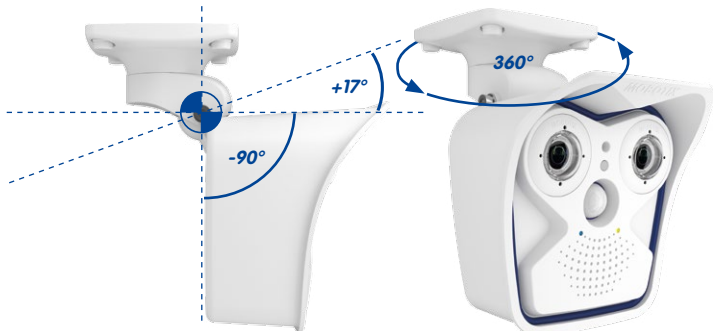

Tilting the camera when installed on a ceiling
 • Horizontal: 360°
 • Vertical: 107°

In addition, a cavity or in-wall socket can be installed for the network cable protruding from the ceiling, which allows sufficient space to use a standard adapter to connect the network cable with the camera patch cable.

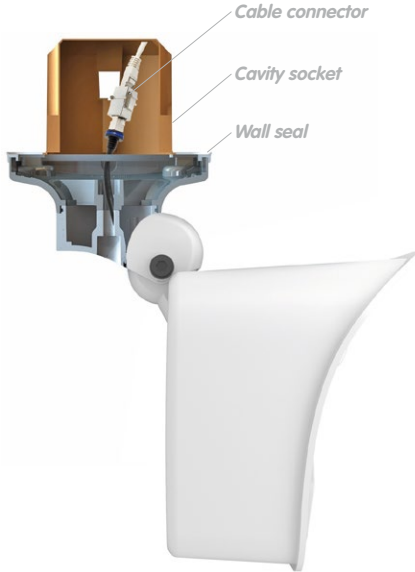

When installing **on-wall cabling**, breaking out one of the four provided openings in the base of the ceiling mount will ensure that the cables can be fed neatly into the camera. The camera patch cable must be connected with the network cable using a suitably sealed adapter.

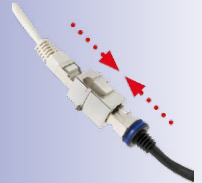
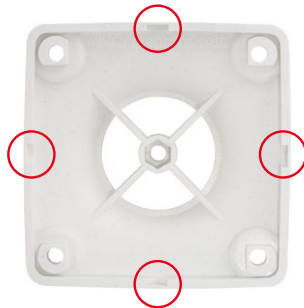

Standard adapter for cable connection

Additional sealing of the wall mount with silicone (on the wall seal) is recommended for use with uneven surfaces

Pliers to break through a cable guide



Procedure

1. **Convert to a ceiling mount:** Simply remove the lock screw on the central joint and exchange the wall mount for the supplied ceiling mount. Before fastening the ceiling mount to the central joint (using the screw of the wall mount), the patch cable is guided through one of the four openings.



2. **Install and prepare the network connection:** Guide the pre-installed camera patch cable through one of the four openings in the ceiling mount (this will be connected later with the network cable using a suitable adapter, for example, in an existing cavity socket).

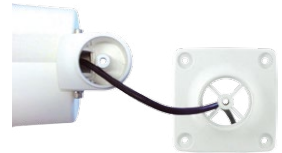

3. **Drill the holes:** Use the supplied drilling template for the camera (found at the end of the manual). Drill the holes for the supplied screw anchors. Screw anchors do not have to be fitted if the surface is made of wood. To secure the mount, the supplied stainless steel hex head screws will be screwed directly into the surface later on. You should start with a 2-mm drill bit, for example (drilling depth just slightly less than screw length), in order to facilitate screwing in wood.

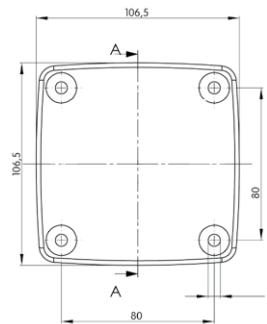

4. **Attach ceiling seal:** Place the white rubber seal with the groove on the edge of the ceiling mount.
5. **Connect the cable:** Connect camera patch cable via connector. Make sure that the cable is not bent or squashed.



No screw anchors are required for wooden surfaces

Additional sealing possible, for example, with shrink tubing



- Mount the camera:** Place the ceiling mount over the drill holes, use the four screws each with a washer and tighten them using the appropriate screwdriver. Do not overtighten the screws as this may damage the plastic mount. Check that the screws are securely in place and place the white screw caps on the screw heads. Then aim the camera as described in *Section 3.3*.



Screw caps for lock screws

- Clean sensor modules:** Clean the protective glass and the dome of the sensor modules with a clean soft cotton cloth for optimal image results.



- Establish a connection to the camera, check the image:** Establish a connection to the camera as described in *Section 3.1, «Manual and Automatic Operation – Overview»* and the following sections. The live image from the camera should be visible on the computer monitor. Check image sections on the computer monitor.

Note

The **VarioFlex mount** and **wall mount** must always be used for **wall installation** (see *Section 2.3, «Mounting The Camera With Wall Mount»*).

2.5 Mounting The Camera With Pole Mount (Accessories)



If you are intending to install the camera on a pole, you should consider using the MOBOTIX M15 pole mount. This mount is made of 3-mm powder-coated stainless steel (white) and has been designed specifically for outdoor use. The supplied stainless steel straps allow the mount to be attached to poles with diameters between 60 mm and 180 mm. By design, the pole mount does not allow the use of an in-wall socket. We recommend using an MX-Patch-Box that can be easily inserted into the cavity socket of the wall mount (VarioFlex mount) in order to ensure a weatherproof connection of the network devices. For more information on the MX-Patch-Box, please visit www.mobotix.com and go to the **Products > Accessories > Interface Boxes** section.

The camera is always installed together with the VarioFlex mount, which is shipped as a wall mount, and can also be installed directly on the pole mount. The best camera position for the selected sensor module must be found before installing the camera (see *Section 2.2, «First Installation Steps»*). You can fine-tune its position once the camera has been installed on the wall.



2.5.1 Pole Mount (MX-MH-SecureFlex-ESWS)

When mounted to a pole, the camera can be turned or tilted similar to wall installations:

- horizontally: 180°
- vertically: 80°

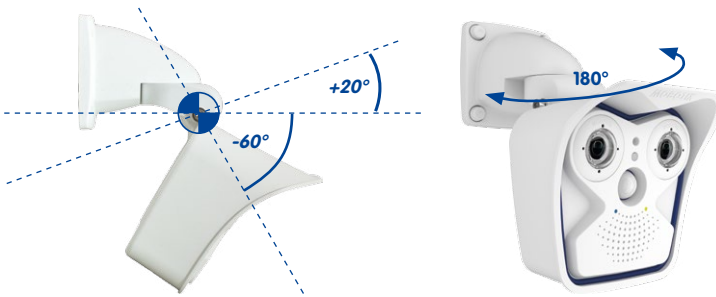

Tilting the camera when installed on a pole

- Horizontal: 180°
- Vertical: 80°

If the wall mount is rotated by 90 degrees, you can also point the camera all the way down:

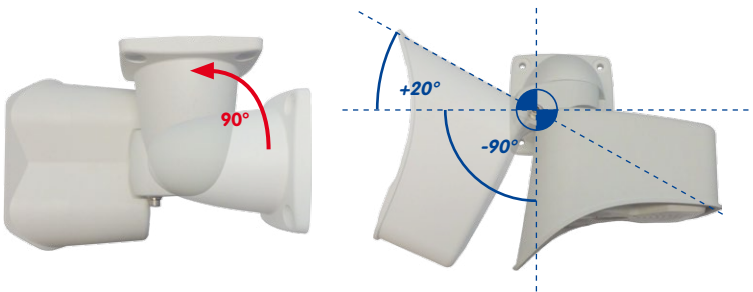

Pole Mount Dimensions



Scope Of Delivery And Required Parts

Please first check that all the components supplied with the corner and pole mount set are present in the original packaging.

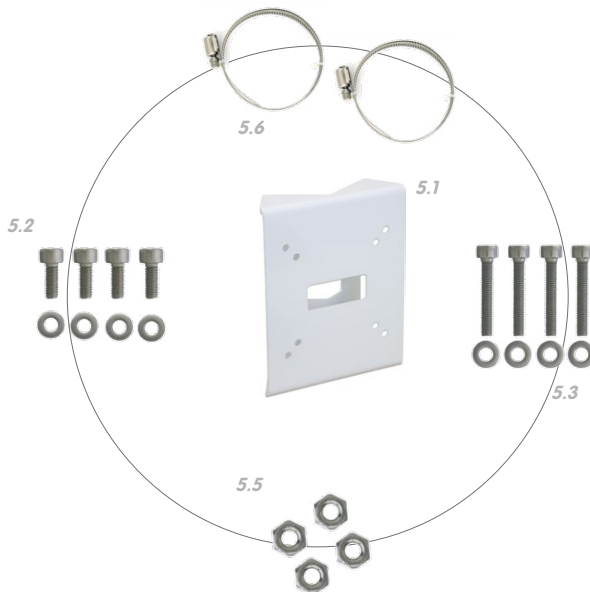

Item	Number	Part Name
5.1	1	Pole mount
5.2	4	Stainless steel hex head screws M6x20 mm
5.3	4	Stainless steel hex head screws M6x35 mm (not required)
5.4	8	Stainless steel washers
5.5	4	Stainless steel hex nuts M6
5.6	2	Stainless steel straps

The caps for the screws are also required here. These are included in the delivery of the M15 basic module (see Section 1.3, «Delivered Parts and Dimensions», item M.10).



Screw caps for
lock screws

Procedure

1. **Prepare the cable:** Guide the on-site network cable from behind through the middle opening of the pole mount. Ideally, the cable should be guided directly from the pole into the cavity socket of the VarioFlex wall mount, where it is connected with the camera patch cable (concealed cabling) via an adapter (such as MX-Patch-Box).



2. **Prepare the straps:** Guide the two stainless steel straps through the pole mount. The pole must have a diameter between 60 mm and 180 mm.



3. **Attach pole mount:** Place the straps around the pole and tighten them using a screwdriver. If necessary, the ends of the straps can be cut off.



4. **Attach rubber sealing ring:** Place the white rubber sealing ring with the groove on the edge of the wall mount.



5. **Connect the cable:** Connect the on-site network cable to the camera patch cable using an adapter or insert the patch cable into the RJ45 outlet. Take note of the installation manual included in the package when using a MX-Patch-Box. All manuals can be downloaded and printed (as PDF files) from the MOBOTIX website (www.mobotix.com) in the **Support > Manuals** section. Make sure that the cables are not bent or squashed.





Screw caps for
lock screws

- Mount the camera:** Place the wall mount over the predrilled positions in the pole mount and tighten it using the supplied M6x25 mm screws (item 1.2), washers (item 1.4) and M6 hex nuts (item 1.5). Place the white caps on the screw heads. Then aim the camera as described in *Section 3.3*.



- Clean sensor modules:** Clean the protective glass and the dome of the sensor modules with a clean soft cotton cloth for optimal image results.



- Establish a connection to the camera, check the image:** Establish a connection to the camera as described in *Section 3.1, «Manual and Automatic Operation – Overview»* and the following sections. The live image from the camera should be visible on the computer monitor. Check image sections on the computer monitor.

Note

The **VarioFlex mount** and **wall mount** must always be used for **pole installation**. The VarioFlex ceiling mount should **not** be used.

2.6 Replacing The MicroSD Card

The camera must be taken down to remove, insert, or replace a MicroSD card in use. To avoid data loss, be sure to deactivate MicroSD card recording in the camera software and reboot the MOBOTIX camera before removing the card.

Caution

A MicroSD card may only be removed from the camera after you have deactivated recording to the SD card and rebooted the camera. Failing to do so may lead to data loss! Make sure that the card is not write-protected!

Procedure

1. **Deactivate recording:** Recording to the SD card must be deactivated (**Admin Menu > Storage on External File Server/Flash Device**). If the MicroSD card recording is still active, deactivate recording, reboot the camera and then disconnect its power supply. For more information, see *Section 3.5, «MicroSD Card Recording»*.
2. **Open camera housing:** Open the camera housing as described in *Section 2.2.2*.
3. **Remove connection cable from the inner cover of the housing:** Remove the connector of the sensor cable and the I/O cable (red clips) after opening the clip catches. Remove Ethernet cable and any connected MiniUSB cable after opening the bayonet catch. Remove MxBus cables. Make sure the front element with the sensor modules does not fall down.



4. **Remove inner cover:** Remove the four lock screws on the inner lid (red arrow) using the supplied 2.5-mm Allen wrench and carefully lift off the lid.

Make sure that the interconnections between the inner lid and the circuit board are not damaged when removing the inner lid.

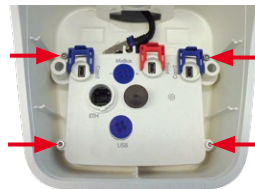

The MicroSD card is located at the top in the center of the circuit board.

Make sure not to touch the circuit board when replacing the MicroSD card!

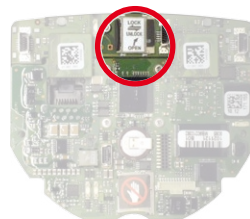

5. **Unlock MicroSD card:** *Carefully* slide the metal latch to the right (using your fingernail).



6. **Remove the MicroSD card:** Lift the metal latch upwards and to the right and remove the SD card.

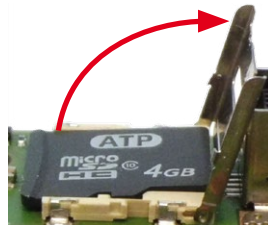

7. **Insert and lock the MicroSD card:** Insert the MicroSD card and close the metal latch. Gently slide the metal latch (using your fingernail) back to the left to lock the MicroSD card.

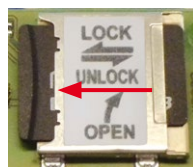

8. **Attach inner cover:** Attach inner cover, tighten Allen screws and replace the connection cables.

9. **Close camera housing:** Close the camera housing as described in *Section 2.2.8*, then reconnect the power supply.



10. **Activate recording:** If you have inserted a MicroSD card that has already been MxFFS formatted, you can activate recording under **Admin Menu > Storage** on External File Server/Flash Device. Once the camera has been rebooted, it automatically activates recording.

11. **Format MicroSD card:** If a new MicroSD card is used, it must be formatted before use as described in *Section 3.5.2, «Formatting The MicroSD Card»*.

2.7 Network And Power Connection

- Power is supplied to the camera via the camera Ethernet connection (patch or installation cable). We recommend using a MOBOTIX PoE adapter or another similar high-quality PoE product to loop-in the power supply:
 - **One camera:** with the PoE adapter (MX-NPA-PoE or MX-NPA-Box)
 - **Multiple cameras:** with PoE products conforming to IEEE 802.3af (PoE switch)
- The **maximum length** of the network cable for power supply over an Ethernet cable is **100 m**.
- Make sure that you only use switches or routers that support the **10/100 Mbps network interface** of the camera.
- We highly recommend using uninterruptible power supplies (UPS) to provide backup power.
- If you are using IEEE 802.3af or IEEE 802.3at (PoE+) Power-over-Ethernet network components to supply power to MOBOTIX cameras, make sure, if possible, that these components do not have a fan. Since the power consumption of MOBOTIX cameras is very low compared to other products, the reliability of the entire system is increased, thus extending the life of these components.

Caution

Appliances with a maximum total power consumption of four watts may be connected to the MxBus connector **and** USB connector **if power is supplied to the camera using PoE class 3**. If **PoE Class 2** is used, **the power consumption of all the connected appliances should not exceed one watt!**

For information on changing the PoE class, see *Section 2.7.5, «Variable PoE»*.

Connection of additional devices with more than 1 W (via MxBus/USB):
Max. ambient temperature +50°C/+122°F

2.7.1 Network Cabling For M15 With Patch Cables

Using a patch cable and an MX-Patch-Box or MX-NPA-Box offers the following advantages:

- Quick installation/deinstallation
- No shortening of the cable in the event of multiple installation/removal
- Hose-proof/dust-proof connection in accordance with IP66

Connecting The Patch Cable To An MX-Patch-Box, MX-NPA-Box Or Standard Network Port

First remove the blue bayonet catch and the blue sealing plug in the right-hand connector on the box to establish the network connection to an MX-Patch-Box or MX-NPA-Box. Then insert the MOBOTIX patch cable into the box and secure the cable using the bayonet catch.

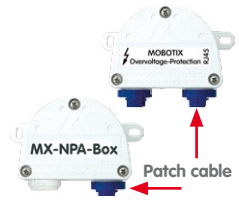

More information on installing an **MX-Patch-Box** or **MX-NPA-Box** is available at www.mobotix.com under **Products > Accessories > Interface Boxes**.

Insert the MOBOTIX patch cable of the M15 into the network port for standard connections (only permitted in indoor areas).

If additional cables are required inside the housing, they must be connected as described in *Section 2.2.6, «Connecting a USB Cable»* and *Section 2.2.7, «Connecting a Two-Wire MxBus Cable»*.

2.7.2 Power Supply Using A Switch

1. Connect the factory pre-installed cable of the camera to the **camera** connector of the PoE adapter.
2. Connect the **LAN/Power** connector of the PoE adapter to the Ethernet connector of the switch/router or the Ethernet port.
3. Plug the RJ45 connector of the power supply unit into the **PC/Power** connector of the PoE adapter.

IP addresses in the diagram are shown only as an example

For the M15 you should use the blue MX-NPA-PoE-Set or the MX-NPA-Box - previous MOBOTIX network power accessories, such as the NPA-Set, Power-Box and Power-Rack (MX-NPA-Set, MX-NPR-4 and MX-NPR8/20) are not suitable for use with the M15

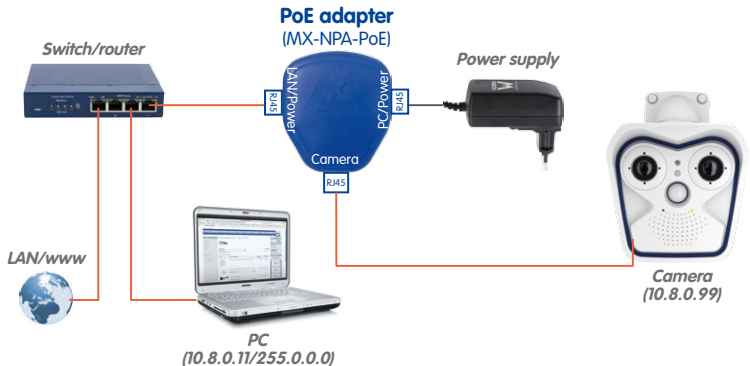

2.7.3 Power Supply When Connected Directly To A Computer

1. Connect the factory pre-installed cable of the camera to the **camera** connector of the PoE adapter.
2. Connect the **PC/Power** connector of the PoE adapter to the Ethernet port of the computer.
3. Plug the RJ45 connector of the power supply unit into the **LAN/Power** connector of the PoE adapter.

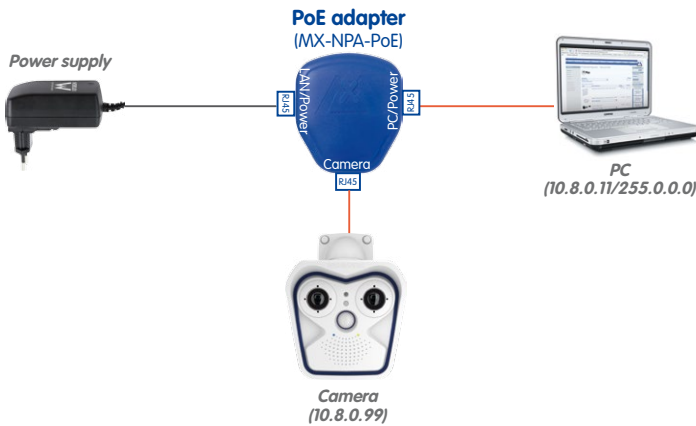

IP addresses in the diagram are shown only as an example

The PoE adapter replaces the crossover cable when directly connecting to a computer

For the M15 you should use the blue MX-NPA-PoE-Set or the MX-NPA-Box - previous MOBOTIX network power accessories, such as the NPA-Set, Power-Box and Power-Rack (MX-NPA-Set, MX-NPR-4 and MX-NPR8/20) are not suitable for use with the M15!



2.7.4 Power Supply With Power-Over-Ethernet Products

Connect the factory pre-installed cable of the camera to a PoE port of the PoE switch/router. The switch/router must support the PoE standards IEEE 802.3af or IEEE 802.3at.

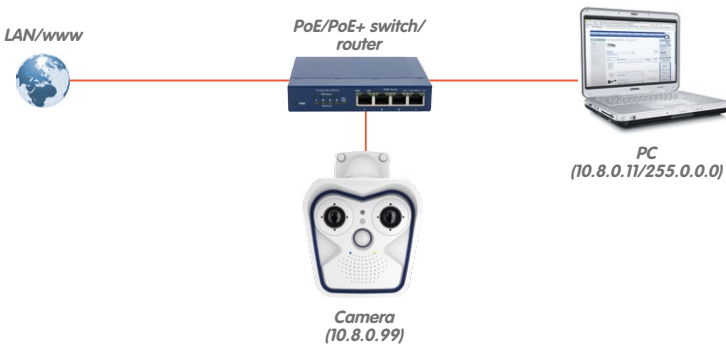

IP addresses in the diagram are shown only as an example

2.7.5 Variable PoE

The power consumption of the camera depends on the functions in use as well as any peripheral devices connected (see table). PoE classes 1, 2 or 3 may be selected in the browser-based user interface in order to optimally adjust the camera to your system design (PoE switch in use, emergency power concept, etc.).

PoE Power Level Classes (IEEE 802.3af standard)		
Class	Max. power consumption	Camera operating mode and peripheral devices
1	0.44 W–3.84 W	LowPower mode; no peripheral devices (available soon)
2	3.84 W–6.49 W	Normal mode; max. 1 W for MxBus peripheral devices
3	6.49 W–12.95 W	FullPower mode; max. 2.5 W for MxBus peripheral devices (for example, MX-GPS-Box and MX-232-IO-Box to MxBus), max. 4 W for peripheral devices to MxBus and USB interface

Caution

If the total power consumption of the camera and peripheral devices exceeds the power provided by the PoE switch for the specified class, the switch can disconnect the camera from the power supply. ***In this case, the camera will only be accessible again once the peripheral devices have been disconnected from the camera and the camera has been restarted.***

Variable PoE:
Multiple cameras
can be operated
simultaneously from
the same switch

The default setting is usually fine, and nothing needs to be changed. However, the PoE power class must be changed in the browser if a higher or a lower power class is required for your application:

1. Select **Admin Menu > Network Setup > Ethernet Interface**.
2. Click on **Change** under **Power Supply**.
3. A **Power Wizard** will appear to guide you through the PoE configuration steps.
4. Next, restart the camera: Disconnect the camera from the power supply. Then reconnect it, for example, by disconnecting and then reconnecting the Ethernet cable at the PoE switch.

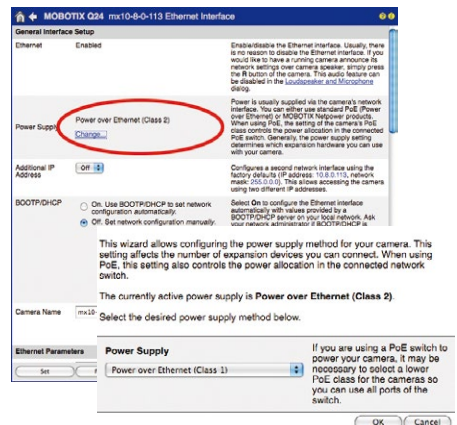

2.7.6 Camera Startup Sequence

As soon as the power supply has been established, LEDs 1 and 2 will show the progress of the startup sequence.

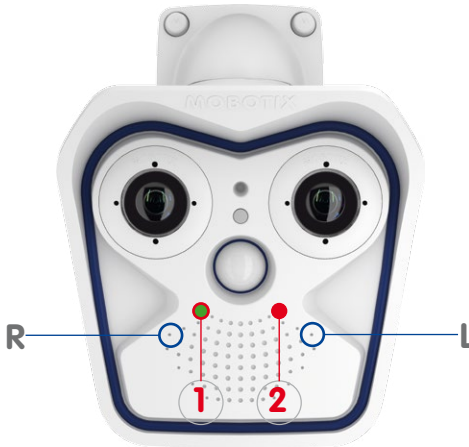

LED default settings:
 1 Power (on), Error (flashes)
 2 Recording (flashes)

- **Booting:** Immediately after connecting the power supply, the red LED lights up, blinks for two seconds, then stays on permanently red. A camera self-test is carried out at this point, and the entire system is started. In case of an error, the camera will start using the backup operating system.
- **Waiting for key pressed:** Both LEDs light up for four seconds. If you press the **R or L key of the camera** during this time, the camera will execute the corresponding function (see Section 3.2.6, «Starting The Camera With An Automatic IP Address (DHCP)» or Section 3.2.5, «Starting The Camera With The Factory IP Address», respectively). To do so, use a **paper clip** but **avoid using sharp or pointed objects!**
- **Ready:** Once the camera software has been started, the green LED is on permanently and the red LED blinks. The camera can now be accessed via the network (browser, MxControlCenter, MxEasy, MOBOTIX App, etc.).

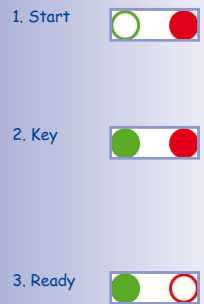

Note

During the startup sequence of the camera, the LEDs will always light up, even if they have been deactivated in **Admin Menu > LED Setup**.

Download the free-of-charge MxEasy and MxControlCenter software at www.mobotix.com

Camera software in the browser

3 OPERATING THE CAMERA

3.1 Manual and Automatic Operation – Overview

MOBOTIX cameras do not require any extra software. Thus, you can set up and operate the MOBOTIX camera using a JavaScript-enabled browser on all common operating systems (such as Windows, Linux, Apple, etc.). As an alternative, you can also use the MOBOTIX applications MxControlCenter and MxEasy. Follow these steps to set up the camera:

1. **Connect the camera to the network.** Power is supplied directly via the Ethernet cable (see Section 2.7, «Network And Power Connection»).
2. **Set up the camera's network parameters:**
 - **Manually using a web browser** (see Section 3.2.1, «Manually Setting Up The Network Parameters In A Browser» and below)
 - **Automatically using MxControlCenter/MxEasy** (see Section 3.2.3 and Section 3.2.4) or **via DHCP** (see Section 3.2.6, «Starting The Camera With An Automatic IP Address (DHCP)»)
3. **Configure the camera** using the web-based user interface, MxControlCenter or MxEasy.

Every MOBOTIX camera comes preconfigured with a static IP address in the 10.x.x range (for example, 10 . 8 . 0 . 99). However, local computer networks usually have IP addresses in the 172 or 192 ranges. In order to access a MOBOTIX camera via the network, the camera needs to obtain an IP address in the same address range. You can **set up the network parameters of the MOBOTIX camera using one of the following methods: Manually, using MxCC and MxEasy or by DHCP.**



3.1.1 Manually Using A Computer In The 10.x.x.x IP Address Range

You can set up the camera's network parameters using a browser and the embedded camera software. To do so, connect the camera to a computer or network that is using a 10.x.x.x IP address range (see Section 3.2.1, «Manually Setting Up The Network Parameters In A Browser»). Afterwards, you can enter the camera's default IP address in the browser's address bar on your computer (see Section 3.2.2, «First Images And The Most Important Settings In The Browser»). Next, click on the **Admin Menu** button to open the camera's Quick Installation in the browser's user interface. This is where you can configure the desired network parameters of the camera. Once you have completed the Quick Installation, you can connect the camera with its new network parameters to the desired network.

The default IP address of your camera is printed on a sticker on the front

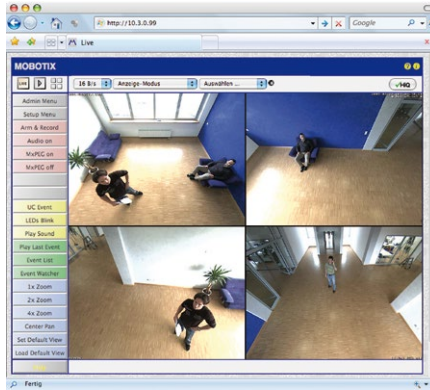

Advantages

- The camera does not need to be physically accessible, that is, it may already be installed.
- No additional software is required.
- The network parameters can be set flexibly through manual entry.

Disadvantages

- The computer or the network needs to operate in the 10.x.x.x IP address range or need to be able to access such a network.
- The setup does not work automatically.
- You need to know the relevant network parameters.

3.1.2 Automatically Using MxControlCenter Or MxEasy

You can set up the camera's network parameters using the free video management software MxControlCenter or MxEasy (see *Section 3.2.3* and *Section 3.2.4*). You can also use one of these applications to automatically configure the network parameters of MOBOTIX cameras that are not operating on the same IP address range as the computer.

Download the free-of-charge MxEasy and MxControlCenter software at www.mobotix.com



Advantages

- You can connect the camera directly to the target network.
- The camera does not need to be physically accessible, that is, it may already be installed.
- The camera can be configured to automatically receive an IP address (optional).
- The network parameters can be manually set (optional).
- You do not need to access the camera software.

Requirement

- Either MxControlCenter or MxEasy must be installed on the computer.

3.1.3 Automatically Using DHCP

The camera can automatically obtain its network parameters using DHCP (Dynamic Host Configuration Protocol). This requires the network to have a functioning DHCP server (for example, a DSL router with activated DHCP server) and the camera must be booted using DHCP (see *Section 3.2.6, «Starting The Camera With An Automatic IP Address (DHCP)»*). The IP address automatically assigned by the DHCP server will be announced via the camera speaker as soon as the camera has booted successfully.

Advantages

- You can connect the camera directly to the target network.
- Network parameters are automatically assigned.
- No additional software is required.
- You do not need to access the camera software.

Disadvantages

- The camera needs to be physically accessible as you need to press a key on the camera housing to boot it using DHCP.
- Requires a running DHCP server on the network.



3.2 First Images And The Most Important Settings

Once the MOBOTIX camera has been connected to the network, you need to set up the camera's network interface accordingly. This step involves setting up and checking the network parameters of the camera. If your network is already using an IP address in the 10.x.x.x range with a 255.0.0.0 network mask, you do not need to change the camera's network parameters. You can access the camera directly (see [Section 3.2.2](#)). If your network or computer does not use an IP address in the 10.x.x.x range (for example, in the 192 or 172 ranges), you should follow one of the following methods for changing the camera's network parameters:

- **Manual setup** (see [Section 3.2.1](#))
- **Automatic setup using MxControlCenter or MxEasy** (see [Section 3.2.3](#) and [Section 3.2.4](#), respectively)

Note

We will use a camera with the factory address 10.8.0.99 in the following examples. Replace this IP address with the IP address of your camera. You will find the IP address of your camera on a small sticker on the camera. Make sure that the IP addresses used in the following examples are not already being used by other devices in the network.

Pressing the "L" key (see [Section 3.2.6](#)) prompts the camera to announce its current IP address over the speaker.

3.2.1 Manually Setting Up The Network Parameters In A Browser

You need a computer that is using a 10.x.x.x IP address in order to manually set up the network parameters of the MOBOTIX camera. The computer's network parameters usually have to be changed for this purpose.

1. Change the network parameters of your computer:

Windows (XP, Vista and 7):

1. Open **Start > Settings > Control Panel > Network Connections**. Clicking on **Properties** opens the dialog box shown.
2. Double-click on **Internet Protocol (TCP/IP)**. On the **General** tab, activate the **Use the following IP address** option. Enter an IP address in the 10.x.x.x range in this field (for example, 10.8.0.11).
3. Once all dialog boxes have been closed, the computer will have the IP address 10.8.0.11.

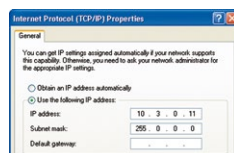
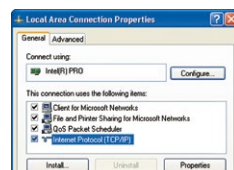

Entry in "Subnet mask" field: 255.0.0.0

Linux/Unix:

1. Open a terminal as `root` user.
2. Enter the following command: `ifconfig eth0:1 10.8.0.11`
3. The computer is now also using the IP address `10.8.0.11`

Mac OS X:

1. Open **System Properties > Network**.
2. Select **Ethernet**. In the **Configuration** field, select **Manual** and enter a 10.x.x.x IP address (for example, 10.8.0.11).
3. Click on **Apply** on the bottom right-hand side of the dialog box to assign the computer the IP address 10.8.0.11.

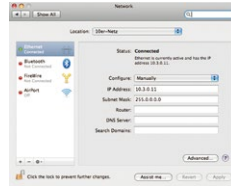

2. Set Up The Target Network Parameters Of The MOBOTIX Camera:

1. Open a web browser on the computer and enter the default IP address of the MOBOTIX camera in the address bar of the browser (for example, 10.8.0.99). Pressing Enter displays the user interface of the MOBOTIX camera (see also *Section 3.2.2, «First Images And The Most Important Settings In The Browser»*).
2. Click on the **Admin Menu** softbutton in the user interface of the MOBOTIX camera. The Quick Installation starts automatically once the *admin* user has logged on.

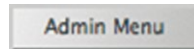

Note: The Quick Installation can also be executed at a later stage by opening **Admin Menu > Network Setup > Quick Installation** (see also *Quick Installation in the Camera Software Manual Part 2*).

3. Enter the target network parameters of the camera on the appropriate page of the Quick Installation assistant.

Note: The network parameters can also be modified retrospectively via **Admin Menu > Network Configuration > Quick Installation**.



4. Once you have completed the Quick Installation and rebooted the camera, the new network parameters will be activated. The camera can now be connected to the target network and, if required, further configured.

Default user data

User name: **admin**
password: **meinsm**

Download the *Software Camera Manual Part 2* from www.mobotix.com in the **Support > Manuals** section

3.2.2 First Images And The Most Important Settings In The Browser

Once the MOBOTIX camera has been connected to the power supply and to the network, you can access the user interface with the live camera image in the web browser. Internet Explorer, Firefox, Safari or any other graphical browser with activated JavaScript is suitable. It does not matter which operating system is used.

After entering the camera's IP address in the browser address bar, you will see the live view of the MOBOTIX camera with its user interface controls, such as softbuttons, buttons for the different camera screens, pull-down menus (Quick Controls), icons for accessing the online help and the camera status, and status information elements.

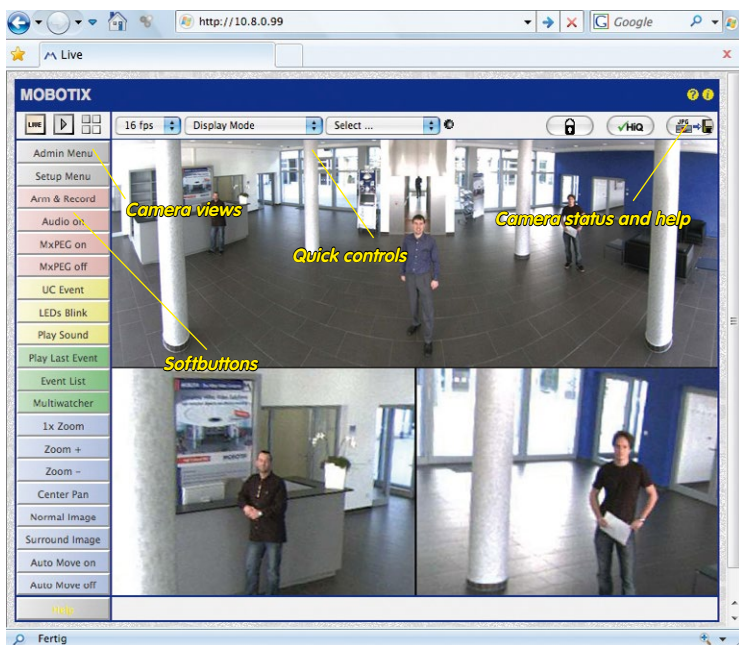

Note

Default access data for the administration menu

- User name: **admin**
- Password: **meinsm**

Camera Views: Live, Player, MultiView

The MOBOTIX camera automatically displays the **live** screen when it starts up (factory default setting). You can set a different start page in **Admin Menu > Language and Start Page** (for example, the **Guest** screen) to allow a restricted access to the live image.

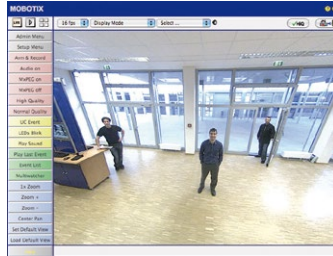

The other available standard screens include **Player** (playback of recorded images and video sequences) and the **MultiView** screen (displays several cameras with live or recorded images).



MultiView allows you to view several cameras via a "proxy" camera (especially useful if you want to access your cameras from outside of the network with reduced bandwidth) and the **PDA** mode provides a special screen for mobile devices.

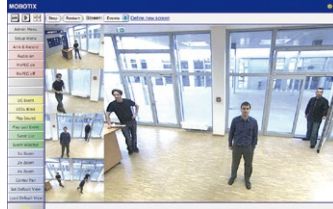

Note

Click on the  icon in the top right corner of the camera's user interface in the browser to find further information on the different camera screens.



Live view:
<http://<camera IP>/control/userimage.html>



Player screen:
<http://<camera IP>/control/player>



MultiView screen:
<http://<camera IP>/control/multiview>

PDA screen:
<http://<camera IP>/pda>

PDA event list:
<http://<camera IP>/control/player?eventlist&pda>

Guest screen:
<http://<camera IP>/cgi-bin/guestimage.html>



3.2.3 First Images And Network Parameter Configuration In MxControlCenter

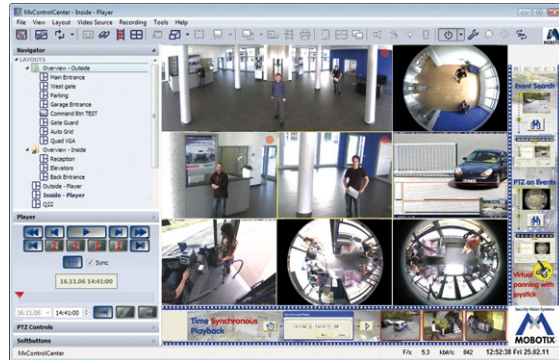

Installation

Download
MxControlCenter
for free from
www.mobotix.com

Download the setup file from the MOBOTIX website to install the latest version. The latest versions are available at www.mobotix.com in the **Support > Software Downloads > MxControlCenter** section.

To install MxControlCenter, simply double-click the setup file and follow the instructions.

The selected files are copied to the computer (older versions will be removed automatically) and the shortcuts are created during the installation process (Desktop, Start Menu, etc.).

Caution

MxControlCenter will automatically attempt to find all MOBOTIX cameras in the physically-connected network (that is, even a MOBOTIX camera with a factory IP address of 10.x.x.x). Make sure that the **firewall settings** on your computer are low enough so that MxControlCenter is not blocked. If any MOBOTIX cameras are found, MxControlCenter can **automatically reconfigure** them so that they are available in the current subnet of the computer. If you do not have permission to modify these settings on your computer, contact your system administrator for assistance.

MOBOTIX– Searching And Displaying Cameras

Launch MxControlCenter after successful installation by double-clicking the shortcut that was created by the installer or the executable file `MxCC.exe` in the installation directory on your computer.

The **Add Video Sources** dialog box appears and the application automatically searches for MOBOTIX cameras in the local network when you launch the program for the first time. Select **Video Source > Add** from the menu to perform a camera search at a later time.

If your MOBOTIX camera is properly connected, it should appear together with the existing video sources in the following list:

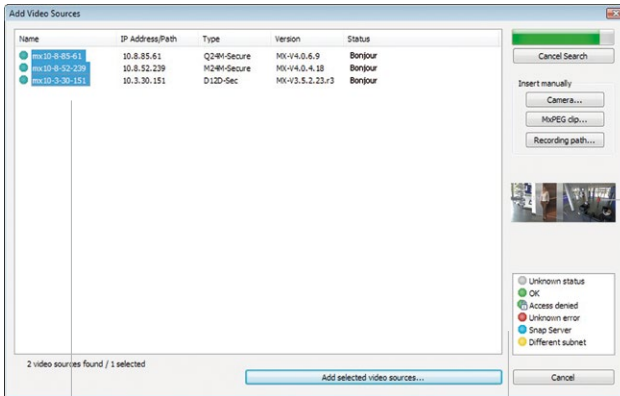

Automated search for MOBOTIX cameras

List of video sources



Legend

Camera preview

Note

Video sources in this context not only refer to MOBOTIX cameras, but also to third-party IP cameras, file server paths, MxPEG clips and analog cameras connected via MxServer (for example, analog dome cameras). These video sources are not found automatically and need to be added manually.

Cameras Are Found But Are Located In A Different Subnet

The symbols in the first column and the legend in the dialog box indicate whether you can access a particular camera directly from the MxControlCenter, which is the case for all cameras designated with  (**OK**). Cameras designated with  (**different subnet**) are located in a different subnet. This usually applies to new cameras or cameras that have been reset to their factory settings.

Note

MxControlCenter finds all MOBOTIX cameras, even when the computer and the cameras are not located in the same subnet.

Once you have marked all of the desired video sources in the list with **OK**, you can now select the ones that you wish to display and manage in MxControlCenter. The live image is automatically displayed in the preview window when a camera is selected to help you identify the cameras.

For cameras marked with **Different subnet** or if you want to add additional video sources, follow the instructions in the following sections. You can also display the selected cameras directly in a layout. For more information, see section «*Creating A New Layout*».

Reconfiguring Cameras In A Different Subnet

If one or more MOBOTIX cameras are displayed with the status **Different subnet** (for example, cameras with a factory IP address), MxControlCenter automatically offers to configure the network settings of the cameras. In this case, the application displays the dialog box shown here after you have clicked on the "Add selected video sources" button. Click **Yes** to configure the cameras to the subnet of your computer.

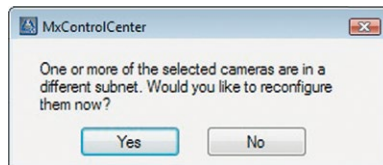

A DHCP server automatically assigns IP addresses for network devices in most networks so that you can automatically select the default setting **Get IP address automatically (DHCP)** in the **Configure selected cameras** dialog box.

Activate the **Use this IP address/this range** option if the IP address of a particular camera must be assigned manually (for networks with static IP addresses). Obtain the assigned IP address, subnet mask and standard gateway from your network administrator and enter the data. All you have to do is enter the range of IP addresses that includes the addresses of all of these cameras to reconfigure multiple cameras at the same time.

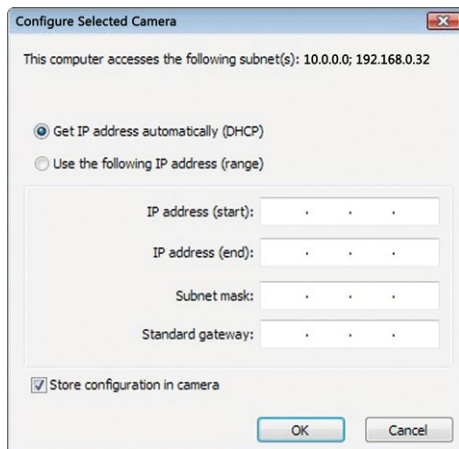

Make sure that the **Store configuration in the camera** checkbox is selected. This setting ensures that the cameras are displayed with the correct network settings even after they have been rebooted. Click **OK** to close the dialog box.

Wait until MxControlCenter has changed the network settings and rebooted the cameras. The status of the reconfigured camera changes from **Different subnet** to **OK**.

Defining Additional Video Sources

In addition to the MOBOTIX cameras that are found automatically, you can also manually add video sources to the list of video sources for MxControlCenter

- **Camera:** Here, you can enter the known IP address or DNS name of a MOBOTIX camera or a third-party IP camera if it was not found by the automatic search feature.
- **MxPEG clip:** Adds an MxPEG video clip previously recorded by a MOBOTIX camera as a video source.
- **Recording path:** Adds the path of an external file server where a MOBOTIX camera has recorded audio/video data. The videos or images recorded at that location can now be played back using the **Player** or **Video Search**.

Editing The Video Source List

Right-click this list to open a shortcut menu from which you can select all video sources or cancel the selection. You can also use this method to remove from the list some or all of the video sources that you do not want to display or manage in MxControlCenter.

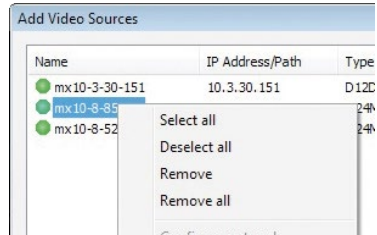

If you have cancelled the camera configuration process or need a password that differs from the camera's factory default password, you can also configure the camera from the shortcut menu at a later date and enter the user name and password required for reconfiguration at that time.

It is also possible to open the **Configure selected cameras** dialog box using the shortcut menu in order to change the camera network parameters.

Creating A New Layout

Select the camera or other video sources that you would like to display in a layout (a view with a group of selected cameras) in the **Add video sources** dialog box and then click **Add selected video sources**.

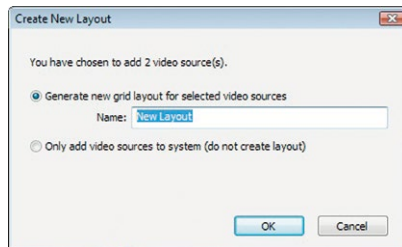

The **Create new layout** dialog box is displayed. If you select the **Generate new grid for selected video sources** option here, MxControlCenter automatically generates a grid layout that displays windows of the same size for all selected video sources. Give each layout a unique name (for example, *Underground garage*).

If you select the second option, the video sources you selected are simply integrated in the MxCC system where you can use them to generate a layout at a later time.

Click **OK** to confirm your selection.

3.2.4 First Images And Network Parameter Configuration In MxEasy

Installing And Starting MxEasy

Download the current version of MxEasy from the MOBOTIX website (www.mobotix.com) > **Support** > **Software Downloads** in the **MxEasy** area). Double-click the shortcut for the program or the program file.

Finding Cameras

When you start MxEasy for the first time on a computer, the MxEasy Wizard automatically begins to search for MOBOTIX cameras and displays all the cameras found in a list. The camera list will be updated automatically as soon as new MOBOTIX cameras are connected to the local network or removed from the network.

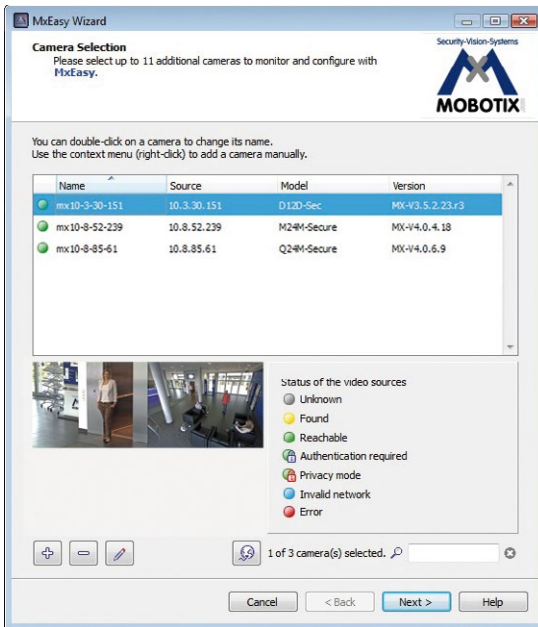

MxEasy also automatically monitors and displays the operating status of all cameras. Cameras that are not on the same subnet as the computer will get a differently colored symbol than the cameras that are on the same subnet. Likewise, the cameras that have an unknown password or for which no user name/password combination has been specified in MxEasy will be displayed in a different color. The following section contains information for cameras with the status **Invalid network** (for example, for all new MOBOTIX cameras with factory settings) and includes tips for configuring the cameras for the "right" subnet.



Download MxEasy
for free from
www.mobotix.com

*Bonjour: automatic recognition of network services in IP networks

Reconfiguring Network Addresses Of Cameras

Using Bonjour*, MxEasy not only finds cameras on the same network as your computer, it also finds MOBOTIX cameras located in other subnets (status **Invalid network**). In such a case, you would not be able to establish any connection to cameras in a different network or subnet (without going into much further detail regarding TCP/IP network configurations). This is possible, for example, when a camera with a factory IP address is connected to a network in which a DHCP server automatically assigns the IP addresses. MxEasy can automatically configure such a camera so that it is "integrated" into your existing network. To do so, you only have to select the affected camera in the list and then click **Continue**.

After a security prompt, a new dialog box for configuring the selected camera is displayed.

The camera "m12 - cki" with IP address "10.4.7.204" has not been set up correctly for access from within your local network.
Would you like to change the network configuration of the camera now?

Get IP address automatically
 Apply to all selected cameras

Use the following IP address
IP address: 192.168.30.*
Subnet mask: 255.255.254.0

This computer accesses the following subnet(s): 192.168.30.0, 10.37.129.0, 10.211.55.0

Cancel OK

If your computer automatically obtains its IP address from a DHCP server, then this is certainly the best choice for that specific camera and most likely for all other cameras that have been found in a different subnet (**Get IP address automatically** option).

If you have assigned a static IP address to your computer, you will probably want to assign static IP addresses (issued by your system administrator) to every camera (the **Use this IP address** option). Normally, you enter the same configuration used for the network settings of your computer.

When you click **OK**, the selected cameras are automatically reconfigured and they are located in the same subnet as the computer.

Integrating And Displaying Cameras

After a camera has been reconfigured, it has the status **Accessible** and can be integrated into MxEasy. The MxEasy Assistant then displays the **Define integration mode in MxEasy** dialog box.

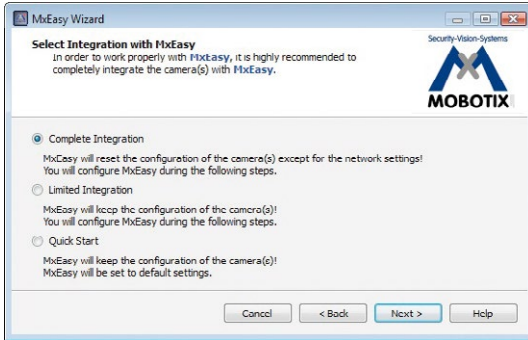

Here, you can jump directly to the main window of MxEasy with the current live camera image by activating the option **Quick Start**. However, some required detailed configurations may have to be made at a later time (for example, password protection, available bandwidth). For this reason, we recommend activating the option **Complete integration** and complete the remaining dialog boxes of the MxEasy Assistant until the main window appears.

After you are done with the MxEasy Assistant, the application's main window appears and displays the first camera:

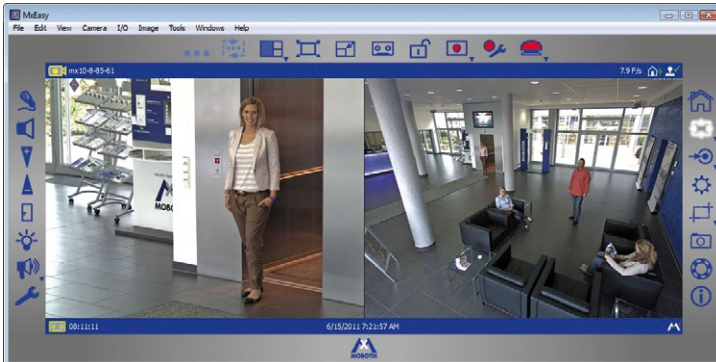

Main window with dual image display of a M15 (telephoto lens and wide angle)

For more information, see the **MxEasy User Manual**, which can be downloaded as a PDF file from the MOBOTIX website: www.mobotix.com > **Support** > **Manuals**.

Passwords and camera settings will not be changed

3.2.5 Starting The Camera With The Factory IP Address

Under certain circumstances, you may have to reset the camera to its factory IP address. This could be the case, for example, if the IP address has been lost or the camera does not respond to the last known IP address. Proceed as follows to start up the camera with its factory IP address:

1. If the camera is powered on, disconnect the power supply by unplugging the corresponding cables and then reconnect the power supply.
2. Wait until both LEDs light up simultaneously for the first time.
3. **Press the L key within the next four seconds and hold it down** (if you need to try again, go back to step 1).



4. **Only release the L key** once the camera emits a single sound ("boing").

Notes

If you use the camera's **L key** to load the factory default network configuration, this configuration is not automatically saved in the camera's flash memory. When the camera is next rebooted without using the **L key**, the last stored network configuration will be used. To permanently store the new network configuration in the camera's flash memory, open **Admin Menu > Store**.

The user information will **not** be reset if the camera is booted using the factory IP address, in contrast to resetting the camera using **Admin Menu > Reset configuration to the factory settings**.

Make sure you store the factory default network configuration to the permanent flash memory

3.2.6 Starting The Camera With An Automatic IP Address (DHCP)

If your network has a DHCP server, you can start the MOBOTIX camera with DHCP support. The camera automatically obtains an IP address from the DHCP server and announces the new network data. Please note that this announcement can only be heard if the camera speaker has been activated.

1. If the camera is powered on, disconnect the power supply by unplugging the corresponding cables and then reconnect the power supply.
2. Wait until both LEDs light up simultaneously for the first time.
3. **Press the R key within the next four seconds and hold it down** (if you need to try again, go back to step 1).

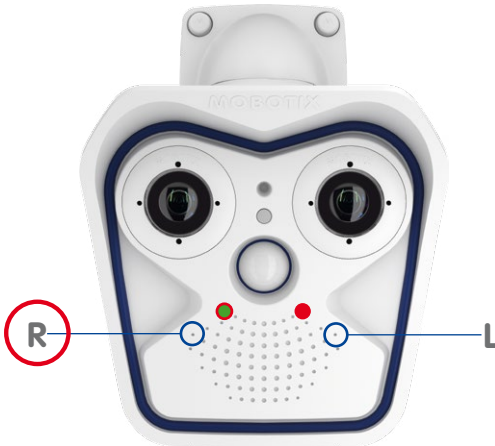

4. **Only release the R key** once the camera emits a double sound (“boing boing”).

Notes

Starting the camera with an automatic IP address (DHCP) is only **temporary**. The network configuration of the camera can be permanently set to DHCP under **Admin Menu > Ethernet Interface**.

Make sure that the network has a functioning server with DHCP support when starting the camera. If this is not the case, the camera cannot obtain a valid IP address and will use its last IP address.

You should also make sure that the cameras always obtain the same IP addresses by permanently assigning the MAC addresses of the cameras to the desired IP addresses.

In case of an error, the camera uses its last IP address

3.3 Adjusting Camera, Lens Focus And Installing Filters

3.3.1 Adjusting The Camera

1. The live image from the camera is displayed on the computer monitor.
2. **Loosen the screws on the VarioFlex mount using the supplied Allen wrench** so that you can easily turn and tilt the camera.
3. Display the desired camera section on the computer monitor, then turn and tilt the camera until you have found the best position and sharpness. Retighten the screws of the VarioFlex mount to prevent the position of the camera from changing.
4. If required, clean the lens using a clean, lint-free cotton cloth.



Correcting The Image Horizon (For L12 Sensor Module Only)

The M15-Sec with hemispheric L12 sensor module allows the correction of an uneven image horizon that was possibly caused by the installation position. The image horizon is turned by up to 30 degrees clockwise or counterclockwise and can be optically restraightened by clicking the icons (see image).

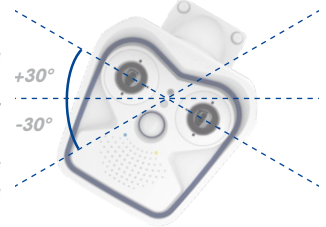

Section 3.4 provides more details and information on the functionality of the OnScreen Control



Correcting the image horizon:

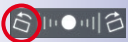

Rotate image to the left



Rotate image to the right

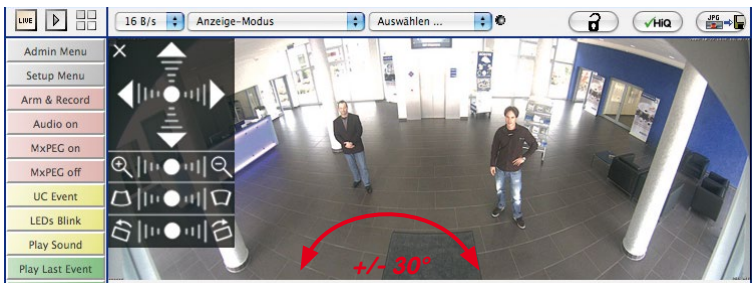

3.3.2 Adjusting Lens Focus (L76/L160 Only)

Once the camera has been installed, the L76 and L160 sensor modules should be checked for proper image sharpness and manually adjusted, if required. To do so, use the blue lens wrench and the black module wrench (both are supplied with the M15 basic module).

The focusing aid provides a visual aid when correcting the image sharpness (see *The Live Screen of the MOBOTIX Camera* in the camera's online help).

Procedure

1. Position the blue lens wrench on the notches of the sensor module. Rotate the wrench **to the left** until you feel a stop (max. 300°) and then a little bit further until the protective glass lens slides out of the sensor module.

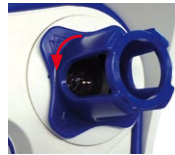

2. Adjust the image sharpness according to the camera's live image on the computer monitor. To do so, position the black module wrench (with the ring-pattern side) on the lens and carefully rotate to the right or left. **Do not turn the lens too far or with force to avoid damaging the image sensor.**



3. If required, clean the inside of the protective glass lens using a clean, lint-free cotton cloth.



4. Place the protective glass lens on the notches of the blue lens wrench.



5. Position the protective glass lens with its clips over the two receptacles on the sensor module (red arrow on the image in the margin) and firmly press onto the sensor module. Rotate the glass **to the right** using the blue lens wrench until you feel a stop.



3.3.3 Inserting A Filter

MOBOTIX offers a polarization filter in its range of accessory products for all sensor modules (except the L12). The polarization filter prevents unwanted reflections from smooth surfaces. The filter can be used to provide better facial recognition of the people behind the windshield of a car, for example. Only one filter can be used per sensor module, which then replaces the standard protective glass lens.

Procedure

1. Position the blue lens wrench on the notches of the protective glass lens. Rotate the wrench **to the left** until you feel a stop (max. 300°) and then a little bit further until the protective glass lens slides out of the sensor module.

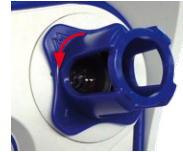

2. If required, clean the inside of the filter using a clean, lint-free cotton cloth.



3. Place the filter on the notches of the blue lens wrench.

4. Position the filter with its clips over the two receptacles on the sensor module (red arrow on the image in the margin) and firmly press onto the sensor module. Rotate the glass **to the right** using the blue lens wrench until you feel a stop.



5. Adjust the **polarization filter** according to the camera's live image on the computer monitor. Rotate the filter to the left using the blue lens wrench until you reach the desired setting (maximum 180°).
6. To readjust the polarization filter, rotate it back **to the right** until you feel a stop and repeat step 4.
7. If required, clean the outside of the filter using a clean, lint-free cotton cloth.

Note

Note that using the **polarization filter** reduces the amount of light that enters the lens by approximately 50 %.



Virtual PTZ And Full Image Recording

3.4 Virtual PTZ And Full Image Recording

3.4.1 Preparing The Virtual PTZ Function

The virtual PTZ function allows you to use a mouse or joystick to continuously zoom in on images from the selected video source and “virtually” move the enlarged image section within the entire image sensor area.

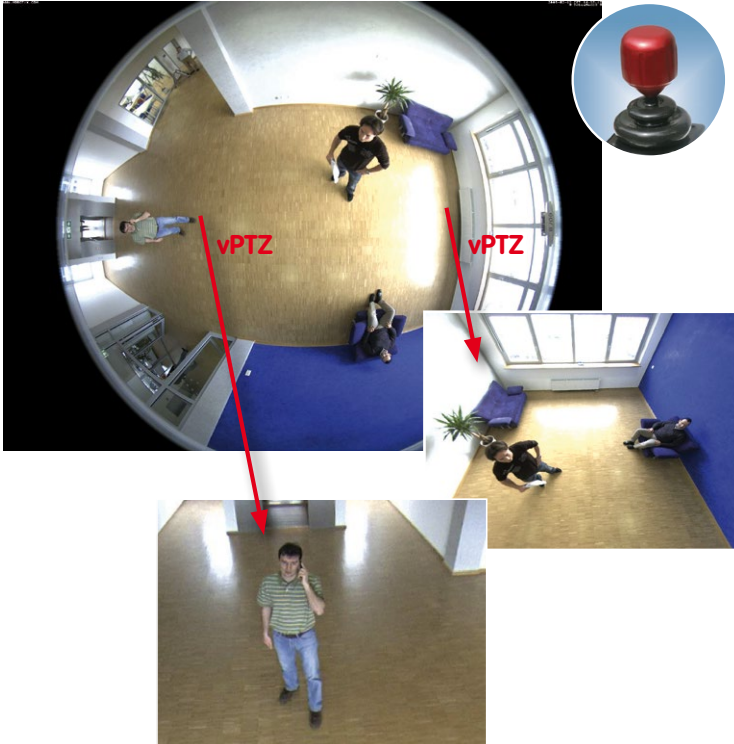

Greater ease of use through a joystick

Operation Using The Mouse And Scroll Wheel

The vPTZ function of the M15 can be controlled in the browser using the mouse. This position becomes the new image center by clicking any position on the image displayed on the monitor. The image moves accordingly and the image distortion is automatically corrected. The **scroll wheel** can be used to control the zoom function. This functionality is disabled in the default settings of the camera and must therefore first be activated. To do so, go to **Setup Menu > vPTZ Settings**, disable **Lock Mouse Wheel Zoom**, click **Set** and then **Close** to save your settings. You can now use the scroll wheel to zoom + (scroll forwards) or zoom - (scroll backwards).

Virtual joystick in
MxControlCenter

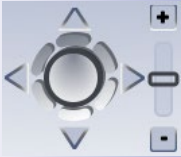

Operation Using USB Joystick

A standard USB joystick can drastically improve vPTZ operation for the user – in the browser, in MxEasy, and in MxControlCenter (however, MxCC is also equipped with a virtual joystick that can be operated using the mouse). Please first install the joystick on the computer according to the manufacturer's instructions.

In order to use a USB joystick in the browser, make sure that you have a PC with a Windows operating system and the latest version of Internet Explorer and that the **“ActiveX” mode in the camera software (browser) is activated:**

- Switch to **Browser** in the Quick Control.
- Under **Browser**, select the option **ActiveX** in the field to the right. The USB joystick can then be used until the browser is closed.
- To store the setting permanently, ActiveX must be activated in the **Admin Menu**. To do so, use **Language and Start Page** in the Admin Menu.
- Under the page options, select the **ActiveX** operating mode.
- Store the settings permanently in the camera by clicking on **Set** and **Close**.
- The joystick can now be used.

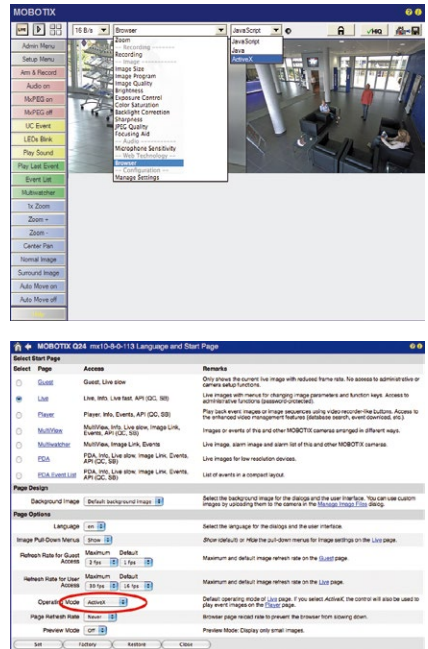

Notes

You will find more information and details on vPTZ in the **Camera Software Manual Part 2** in *Section 4.3.6, «Virtual PTZ»*, the **MxEasy** manual in *Section 2.4.1, «Activating The PTZ Features»* and the **MxControlCenter** manual in *Section 2.4.6, «Using The vPTZ Features»* and *Section 3.1.4, «PTZ Controls In The Sidebar Panel»*.

Current versions of all manuals can be downloaded anytime from the MOBOTIX website (www.mobotix.com) under **Support > Manuals**.

3.4.2 Full Image Recording

It is possible to record a **full image**, regardless of the live image stream that is being displayed. This ensures that the recording always contains the full image of the lens used, even though the operator may have used the vPTZ features to zoom into the image in order to examine a specific detail.

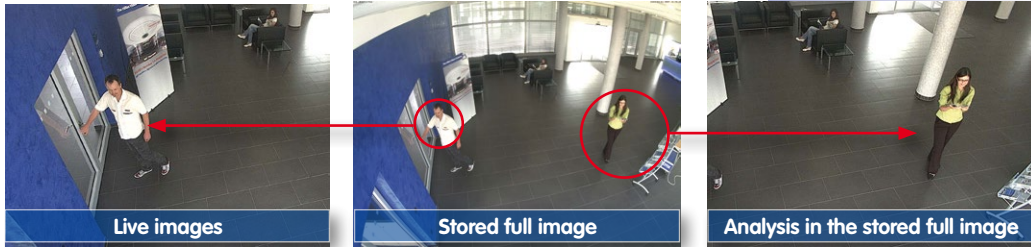

This means that you can use the vPTZ features in VGA resolution to pan, tilt and zoom in the live image while the camera is, for example, recording full images at 1 fps in MEGA or QXGA resolution.

In **MxEasy** and **MxControlCenter**, the recorded full images may be prepared for the user with the vPTZ functions (for example, panning and zooming in on an image detail such as a doorway).

If **full image recording is not activated**, only the last displayed live image will be saved (save what is seen). The **main benefit** of live image storage is to ensure that the full power of the camera processor is used for live image correction and maximum frame rates. The **main advantage of full image recording** lies in the special functionality of the M15, in that it can always maintain availability of a maximum size (full) image for later investigation, despite vPTZ actions carried out on the live image. The mechanical limitations of motor-driven PTZ cameras mean that they simply **cannot** provide this unique advantage to the user!

Stored full image:
Original camera image
without distortion or
image correction

Notes

Post-event search in the full image: If you are using full image recording on M15 cameras, you should use at least MEGA resolution when storing. This will facilitate later searches in **MxControlCenter** or **MxEasy**. The advanced distortion correction features require this function to deliver satisfactory image quality.

Full image recording on: Due to the increased processing time, full image recording reduces the data rate of the live image stream, which may drop by around 10 to 30 percent. We therefore recommend reducing the frame rate for storage as much as possible to affect the live image stream as little as possible.

Full image recording off: The event that triggered a video motion (VideoMotion, VM) window may not be in the recorded sequences because the window was not displayed at the time.

Activate/Deactivate Full Image Recording In The Browser

To configure this feature, open the **Setup Menu > Event Control > Recording** dialog box and activate or deactivate the **Full Image Recording** option.

The screenshot shows the 'Recording' configuration dialog for a MOBOTIX Q24 camera. The 'Full Image Recording' option is highlighted with a red circle and is set to 'On'. The dialog is organized into sections: General Settings, Storage Settings, and Start Recording. The 'Full Image Recording' option is located in the General Settings section.

General Settings	Value	Explanation
Arming	Enable	Arm Recording: Controls camera recording: Enable: activate Recording. Off: deactivate Recording. St: Recording armed by signal input. CS: Recording armed by custom signal as defined in General Event Settings . From Master: copies Recording arming state from master camera. Time Table Profile: Time table profile for time-controlled recording. (Time Tables)
Digital Signing	Off	Digital Signing: Digitally sign the recorded image files using the X.509 certificate of the web server. Manage X.509 certificates of the web server .
Recording Status Symbol	Off	Activate Recording Status Symbol: On will draw a symbol in the image to visualize the current arming and recording status.
Full Image Recording	On	Activate Full Image Recording: On will always record the Full Image of the sensor with the specified parameters . On will record the visible image.
Terminate Recording (TR)	Off	Activate Terminate Recording: Terminate recording if an event is detected. Use this option to freeze stored images. Click here to resume recording.
Storage Settings	Value	Explanation
Recording (REC)	Event Recording	Recording Mode: Type of event and story recording. Snap Shot Recording: stores single JPEG pictures. Event Recording: stores stream files for every event using MxPEG codec. Continuous Recording: continuously streams videodata to stream files using MxPEG codec. Record Audio Data: Store audio data in stream file if available. Enable and configure microphone .
Start Recording	All	Start Recording: Select the events which will start recording. Use [Ctrl]-Click to select more than one event. Events in brackets need to be activated first. EC or EL for filtered events.

Buttons: Set, Factory, Restore, Close, Less

The screenshot shows the 'Full Image Recording' configuration dialog for a MOBOTIX Q24 camera. The 'Image Size' is set to QXGA (2048x1536), 'JPEG Quality' is 60% (High), and 'Text Display' is set to Date & time. The dialog is organized into sections: Attribute, Value, and Explanation.

Attribute	Value	Explanation
Image Size	QXGA (2048x1536)	Image Size: Factory default: <i>Mega (1280x960)</i>
JPEG Quality	60% (High)	JPEG Quality: Factory default: 60%
Text Display	Date & time	Text Display: The <i>Date & Time</i> option will only display date and time. Date and Time: Select format of date and time.

Buttons: Set, Factory, Restore, Close

3.4.3 Special M15 Configuration In The Browser

M15D And Different Sensor Modules

A range of combination options are provided that change the available display modes and configuration possibilities by using the MOBOTIX M15D with different sensor modules.

Because of this, a M15D automatically detects which sensor modules are installed and proceeds as follows:

- When the camera is started for the first time, it detects the connected sensor modules and captures their data (focal length, day or night version).
- If only one sensor module is connected, the camera acts as a mono camera (meaning that there is no automatic day/night switching, etc.).
- If there is no change within the first 12 hours of operation, the camera writes the details of these sensor modules to the camera configuration.
- With every restart, the camera checks if the stored sensor modules are present. If the sensor configuration has changed in the meantime (e.g., because a sensor module has been exchanged), **the camera shows a corresponding message in the live image**. To store the changed sensor configuration in the camera, proceed as described at the end of *Section 3.4.3, «Special M15 Configuration In The Browser»*.

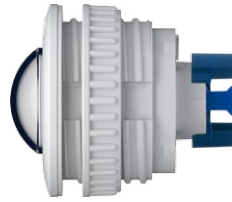

L12 sensor module

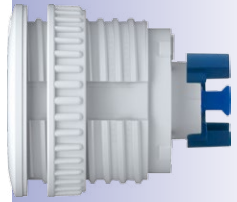

L25, L38, L51, L76,
L160 sensor modules

Configuration Of The M15 Basic Parameters for Hemispheric Sensor Modules

Thanks to its hemispherical lens, the MOBOTIX M15 provides certain special configuration options for the image settings. Depending on where the camera is installed (ceiling, wall or floor) and on the live image display preferred by the user, certain important basic settings and, if necessary, their adjustment must be configured when a M15 is first installed.



Complete the steps described below in the browser window:

1. **Log the camera on and boot it** as described in *Section 3.2, «First Images And The Most Important Settings»*. Depending on the number of sensor modules used, proceed as follows:
 - **One sensor module:** Proceed with step 2.
 - **Two sensor modules:** In this case, the remaining steps need to be executed separately for each sensor module. Specify each sensor module's installation position separately in the **Installation (right)** and **Installation (left)** Quick Control fields for the right and left sensor module (i.e., camera image), respectively. If you need to use the OnScreen Control (see next section), click into the corresponding sub image when viewing a dual image or show the image of only one sensor module.
2. **Select installation position wall/ceiling/floor:** Click **Installation** in the Quick Control panel and then select **Wall**, **Ceiling** or **Floor** according to the installation position of the camera. **Ceiling** always means that the orientation of the camera or sensor module is from **top to bottom** and for **Floor**, the camera or sensor module's orientation is from **bottom to top**.

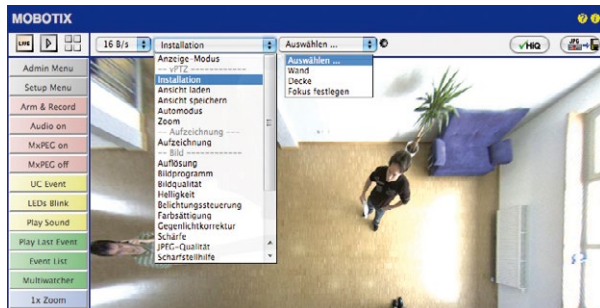

As a result, you will get a **perspective-corrected panorama view** for each image sensor matching the specified installation position. Panorama view is configured as the factory setting and it can be changed as described below.

3. Switch to the **Display Mode** Quick Control.
4. Set the mode that you want to be the standard view. For demonstration purposes, the descriptions below describe the typical display mode for the wall mount and the ceiling mount, **Panorama** and **Surround** respectively. Every other display mode can be operated in the same way.



Left and right camera images from two sensor modules (M15D)

Wall-Mounted: Setting And Correcting the Standard View "Panorama"

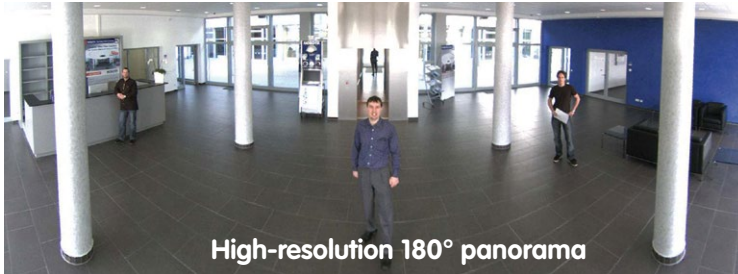

Camera live image with panorama correction

1. In the **Display Mode** Quick Control, select the **Panorama** option. Examine the image that is now displayed. If the section meets your expectations, no further adjustment is necessary, and panorama configuration is complete. To change the image section to meet your specific expectations, continue with step 2.

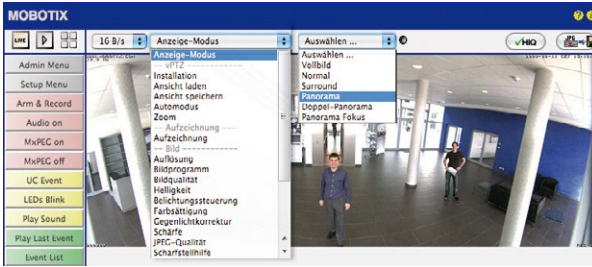

Camera live image without MOBOTIX panorama correction with Quick Controls visible

Note

The currently visible image section may differ from the desired image section due to the installation position or any accessories in use, for example. However, it is not necessary to physically move the camera, as in this case the browser alone can be used to adjust the visible panorama image by zooming, panning and tilting. Tilted vertical lines may also be optically straightened to the image edges using the panorama correction function. These tilted lines are primarily caused if the camera or sensor module is tilted (for example, due to mounting with 15° wedges) or if the image tilt is modified.

- Click the **lock icon**. Clicking the lock once opens it (lock clasp is raised). The lock prevents execution of later vPTZ actions, which could also unintentionally modify the view you configure. This applies to all overview display modes, that is, also to Panorama/Focus, Double Panorama and Surround.

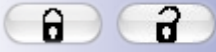

Lock open



- A new **icon for processing the panorama image** appears in the top left corner of the camera image. Enlarge the image by clicking the icon once (OnScreen Control appears).



Click the icon



- Using the **OnScreen Control** visible in the live camera image, you can now change the displayed live camera image as desired (panning, tilting, zooming, rotating and panorama correction). See figure on the right. When doing so, the vPTZ function using the mouse or joystick is deactivated. In case of a M15D with two sensor modules, click the corresponding camera image (right/left) to edit it (highlighted with a yellow frame).



Camera live image with panorama correction with OnScreen Control visible

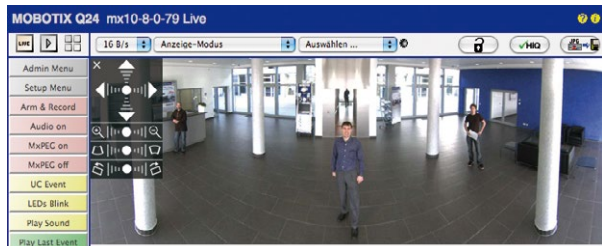

- After you have modified the desired setting, close the control panel ("X" in the top left hand corner).
- Click the lock icon again** to close it (lock clasp is down). The panorama image setting is then locked until the camera is next restarted.

Caution

To permanently save the standard image setting defined for the M15, go to the **Store Complete Configuration** option in the **Manage Settings** Quick Control. The settings will then remain in effect, even after rebooting.

Functions Of The M15's OnScreen Control

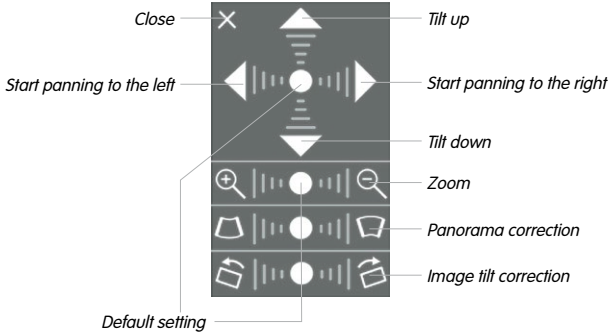

To use the OnScreen Control, click the arrows in the top area for shifting the image section. In the bottom areas, which are displayed when needed, click to the left and/or right of the center point.

The same applies to every area: **The further away that you click from an area's center point, the greater the change triggered.** To reset an area, click its center point again.

During panorama correction, clicking between the two trapezoid symbols straightens the left or right tilting lines, which are best visible at the edges of the image section.



Depending on the installation position (ceiling, wall, floor), panorama correction and image tilt correction may not be available

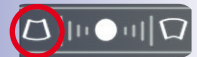

Bring columns together at the top (necessary to correct the example on the left)

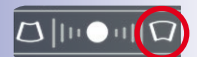

Bring columns together at the bottom

Ceiling-Mounted: Set North (User-Defined North Direction)

Once a sensor module (M15D) or entire camera (M15D) is installed on a ceiling, you need to specify its North direction. This is not the “true” direction of North but rather the **main line of sight or the focus** of the camera or sensor module. It serves as a reference for the North direction in the **Surround** and **Double Panorama** display modes (the **Ceiling** option was already selected in the **Installation Type** Quick Control).

1. In the case of a double image, click the corresponding sensor module (camera image) and select the **Normal** option from the **Display Mode** Quick Control.



2. **Rotate the live image** in the desired direction using the mouse or a joystick connected to the computer.

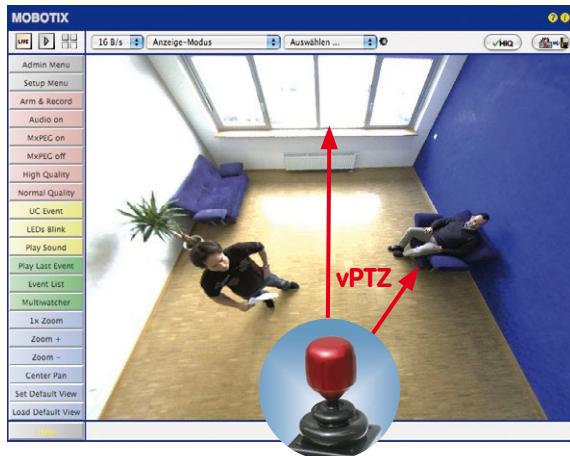

For vPTZ use and the configuration of a USB joystick, see Section 3.4.1

- In the **Installation Quick Control**, select the **Set North** option.

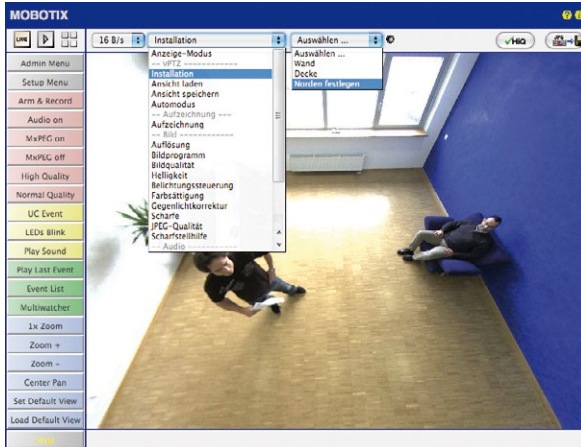

- Store the desired North direction permanently by first activating the checkbox and then clicking on **Yes**.

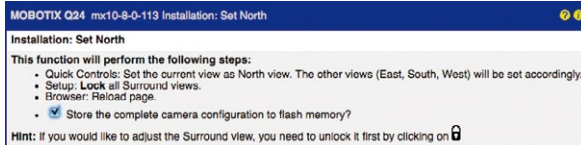

- You have now set the North direction for the **Surround** and **Double Panorama** display modes. In the next step, you can set these views as the standard view for the camera live image.



Caution: No OnScreen Control is available in "Double Panorama" mode



In the **Display Mode** Quick Control, select the option **Surround or Double Panorama**. You can fine-tune the views using the vPTZ via mouse or joystick and, as described above, by unlocking and locking the standard view using the lock icon (open lock, correct display and close lock again).

Note

For each of the **subviews** (*North, East, etc.*; see below), the **OnScreen Control** on the side can be used to adapt it (open lock, click subview, adapt view, click next subview, adapt view and close lock again).

Camera Images And Subviews Of Camera Images

The M15D's ability to operate multiple sensor modules means that in double image display, the live image's **camera images** (left, right) can be used for differing display modes. Depending on the display mode selected for each camera image, this may be divided into **subviews**:

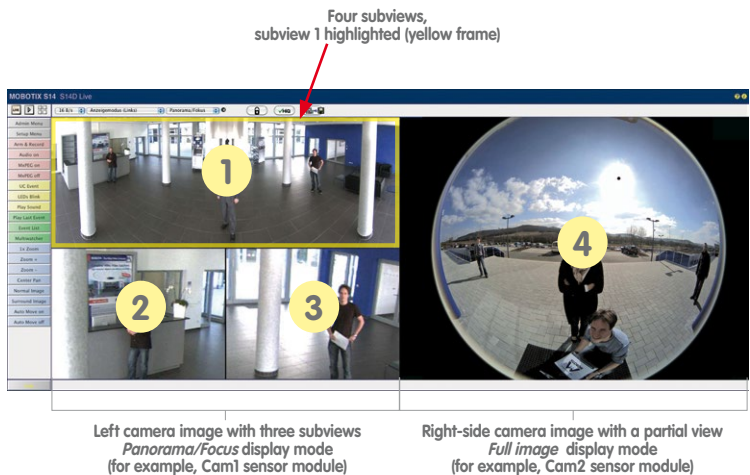

When you click inside one of the subviews, this area is highlighted with a yellow frame. All of the PTZ actions triggered by the mouse, joystick or OnScreen Control now only apply to the highlighted subview.

Sensor Configuration (Only with Two Sensor Modules)

Sensor configuration specifies which sensor module is connected to which of the camera's connections (**Cam1** or **Cam2**), and in which camera image (left/right) the sensor module is to appear for the dual image display. Open the corresponding dialog box here: **Admin Menu > Sensor Configuration**.

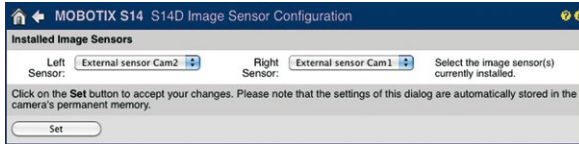

You should also open the **Sensor Configuration** dialog box in the following cases:

- **Swapping the displayed camera images:** You wish to display the left camera image on the right (and vice versa) without having to replug the sensor module cables on the camera itself.
- **Replacement of sensor modules:** In this case, the M15D detects after startup that the sensor modules have been replaced and indicates this through an alert superimposed on the live image as well as through a system message (**Admin Menu > System Messages**; see Section 3.4.3, «Special M15 Configuration In The Browser»).
- Adding/switching on sensor modules: This is where you can re-enable deactivated modules.
- **Removing/switching off sensor modules:** This is where you can deactivate any connected modules if needed.



More robust than hard drives: Flash drives for recordings

3.5 MicroSD Card Recording

3.5.1 Introduction

Flash-based storage devices (MicroSD cards, USB sticks and solid-state drives) do not contain any moving parts as compared to the commonly used hard drives. Flash-based storage devices are compact and highly resistant to moisture and vibrations. They feature low energy consumption and they do not lose any data in the event of a power failure, meaning that they are ideal for use with MOBOTIX cameras.



Number Of Write/Delete Cycles Per Flash Storage Cell

The number of write/delete cycles of every storage cell of a flash device is limited. The controller of the flash device automatically detects individual flash cells that are no longer functioning. The contents of the faulty cell will then be rebuilt using a checksum and will be moved to a properly working spare cell. The faulty storage cell will be marked as “bad” and will no longer be used. No data is lost in this process.

In addition, MOBOTIX cameras constantly monitor activated flash storage devices. MOBOTIX has developed a technology to test the wear of the flash device by logging the number of write/delete cycles (patent pending). The flash memory wear is automatically displayed in the status bar in the live camera image but it can also be viewed at any time in the **Admin Menu > Camera Status** dialog box.

Conservative Memory Usage Thanks To MOBOTIX MxFFS File System

MxFFS formatting of the MicroSD card means that the MOBOTIX camera software will use the flash device as evenly as possible, thus allowing for the maximum possible number of write/delete cycles. This also means that all storage cells of the flash device will be written and deleted with the same frequency, if possible. MOBOTIX technology increases the life of the flash device considerably and also improves the security and the reliability of the storage process.

Storage Requirements And Life Expectancy Of MicroSD Cards

The life expectancy of a MicroSD card increases proportionally to the storage capacity, since the camera software will execute fewer write/delete cycles on each storage cell. The first deletion will begin once the SD card has been filled to capacity (first full cycle).

All specifications are based on calculated averages

32 GB MicroSD Card: Storage Requirements					
	6 fps CIF	6 fps VGA		1 fps MEGA	1 fps QXGA
	M-JPEG	M-JPEG	MxPEG	M-JPEG	M-JPEG
File size single image	15 kB	45 kB	–	120 kB	240 kB
Storage required per second	90 kB	270 kB	75 kB	120 kB	240 kB
Storage required per 24 hours	7.8 GB	23.5 GB	6.5 GB	10.4 GB	20.8 GB
Time for one full cycle	4 days	1.3 days	4.8 days	3 days	1.5 days

4 GB MicroSD Card: Storage Requirements					
	6 fps CIF	6 fps VGA		1 fps MEGA	1 fps QXGA
	M-JPEG	M-JPEG	MxPEG	M-JPEG	M-JPEG
File size single image	15 kB	45 kB	–	120 kB	240 kB
Storage required per second	90 kB	270 kB	75 kB	120 kB	240 kB
Storage required per 24 hours	7.8 GB	23.5 GB	6.5 GB	10.4 GB	20.8 GB
Time for one full cycle	12 hours	4 hours	14.4 hours	9.2 hours	4.4 hours

Caution

The MicroSD card's service life depends on production quality and frequency of use. Set the type of recording (event-controlled or continuous recording, frame rate, resolution) according to your specific requirements.

We recommend changing the pre-installed, high-quality 4 GB MicroSD card once a year if you have it constantly set to continuous recording.

Monitoring The Cell Wear Of Flash Storage Devices (Patent Pending)

MOBOTIX uses its own technology for this purpose and has a pending patent. You can view the flash wear in the status bar of the live image or by opening **Admin Menu > Camera Status**. In addition, the camera can also send a warning message (for example, via e-mail) as soon as a critical error is detected when data is written to the SD card (**Admin Menu > Error Notification Function**). The MicroSD card can then be replaced to ensure that any existing data is not lost.

Dateiserver / Flash-Medium	
Typ	SD Flash Card
Dateisystem	MxFFS
Flash-Abnutzung	1%
Puffer-Auslastung	0% (0: 0%, max: 0%)
Verloren gegangene Alarmbilder	0
Sequenzen	1 (1 Dateien)
Neueste Sequenz	1970-01-01 01:00:00 #0
Älteste Sequenz	1970-01-01 01:00:00 #0
Aktueller Speicherbedarf	4,0 MByte (0.4%)
Max. Größe	936 MByte

Format SD card:
Admin Menu > Storage
on External File
Server/Flash Device

The **Secure deletion – Slow** option takes several hours. You can also use suitable applications on Windows, Linux/UNIX and Mac OS X systems to repartition and safely erase the SD card.

3.5.2 Formatting The MicroSD Card

Before a MOBOTIX camera can store image and video sequences on a MicroSD card, it needs to be formatted as MxFFS (MicroSD cards delivered with MOBOTIX cameras are already MxFFS-formatted). The following steps are necessary to format a storage device (**Admin Menu > Storage on External File Server/Flash Device**):

1. Make sure that there is a MicroSD card in the card slot of the MOBOTIX camera.
2. Click **Format** in the **SD Memory Card** line.

3. Note down the characters shown in the **Encryption password** field or enter your own password. Next, click **OK**.

Note: The **Secure deletion – Slow** option will ensure that any data on the MicroSD card is overwritten completely so that the data cannot be recovered in any way. However, keep in mind that this kind of safe formatting takes considerably more time.

4. In the next dialog box, enter the user name and the password of a user of the **admins** group and click **OK** to confirm.

The MOBOTIX camera now starts formatting the card. It takes 5 to 12 minutes to format an 8 GB MicroSD card if the **Secure deletion – Slow** option is disabled. If **Secure deletion – Slow** is enabled, this may take anywhere between 3 and 14 hours.

Once the formatting has been completed, you can activate the MicroSD card for recording (see next section).

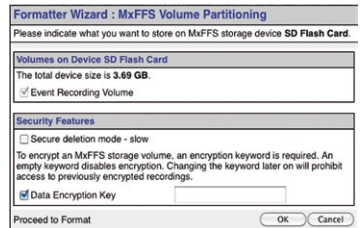
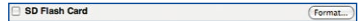

Caution

Make sure that you always wait until the formatting process has been completed before accessing the camera again. If the **Secure deletion – Slow** option is disabled, this usually takes just a few minutes. You can only access the MicroSD card once MxFFS formatting has been completed.

Formatting with the **Secure deletion – Slow** option enabled takes several hours. You can also use suitable applications on Windows, Linux/UNIX and Mac OS X systems to repartition and safely erase the MicroSD card.

3.5.3 Activating Recording

Follow these steps to activate the recording to a MicroSD card that has already been MxFFS-formatted (**Admin Menu > Storage on External File Server/Flash Device**):

1. Make sure that there is a MicroSD card in the card slot of the MOBOTIX camera.
2. Make sure that the MicroSD card is formatted in MxFFS format.
3. Activate the **SD Memory Card** option.
4. Click **Set** and then **Close** to store the configuration.
5. Reboot the MOBOTIX camera (**Admin Menu > Reboot Camera**).

Once the camera has rebooted, make sure that the camera displays the **FR REC** symbol in its live image. If this is the case, the camera uses the MicroSD card as recording target. If not, you must activate the recording (see below).

Activating The Recording

If the **FR REC** symbol is not visible in the live image after rebooting, you need to activate the recording using one of the following methods:

- **In the web browser:** Automatic activation by clicking on the **Arm & Record** softbutton. Confirm this in the Easy Dialog by clicking on the **Yes** button.
- **In the web browser:** Manual activation via the Quick Control **Recording > Recording On** or in **Setup Menu > Recording**.
- **MxEasy:** It is possible to activate the recording based on the time or date using the Alarm Planner of MxEasy (see *MxEasy User Manual*).

Encryption And Authentication

All video data stored on the MicroSD card is encrypted to ensure security at all times. The password for this is defined during the card's formatting procedure and needs to be entered for authentication whenever the recordings are accessed (see next section).

Activate recording:
**Admin Menu > Storage
on External File
Server/Flash Device**

3.5.4 Accessing Data on the MicroSD Card

The following options facilitate access to the stored image and video sequences on a MicroSD card:

- **In the web browser:** Play back the recorded event images without sound directly from the MicroSD card using the Playback view of the camera software.
- **In MxEasy:** Play back the recorded video sequences with sound by accessing the MicroSD card in the MOBOTIX camera via the camera.
- **In MxControlCenter:** Play back the recorded video sequences with sound by accessing the MicroSD card in the MOBOTIX camera via the camera or by directly accessing the MicroSD card via a card reader connected to the computer. Access the card by setting the MicroSD card's drive/volume as a **Directory** in MxControlCenter.

If the recordings stored on the MicroSD card were encrypted, you need to enter the password used for the encryption before you can access the data. If this is the case, both MxControlCenter and MxEasy will provide a dialog box for this purpose.

Caution

When **using the MicroSD card from one MOBOTIX camera in another MOBOTIX camera**, you need to make sure that the time on the original camera is in sync with the new camera. We recommend using automatic time synchronization via a time server (**Admin Menu > Date and Time**).

3.5.5 Deactivating Card Recording

Follow these steps to deactivate recording to a MicroSD card (**Admin Menu > Storage on External File Server / Flash Device**):

1. Activate the **None** option.
2. Click on the **Set** button at the bottom of the dialog box and then **Close**.
3. Reboot the MOBOTIX camera (**Admin Menu > Reboot Camera**).

Once the camera has rebooted, make sure that the symbol **FR REC** is no longer visible in the bottom right-hand corner of the live image.

4. You can now safely remove the MicroSD card from the camera (see *Section 2.6, «Replacing The MicroSD Card»*).

Caution

A **MicroSD card may only be removed from the camera after you have deactivated the recording** to MicroSD card and **rebooted the camera**. **Failing to do so may lead to data loss!**

Removing connected flash storage devices from the camera without properly deactivating them may lead to data loss and/or destroy certain sectors of the storage device. This is limited to 4 MB of lost data per incident due to MxFFS formatting.

3.5.6 Using A MicroSD Card In A Different MOBOTIX Camera

A MicroSD card containing recorded data from a MOBOTIX camera can be inserted into any MicroSD card-enabled MOBOTIX camera. Once MicroSD card recording has been activated (requires a reboot), the "new" MOBOTIX camera automatically synchronizes with the card and resumes recording. No data is lost in this process. Make sure that you deactivate MicroSD card recording before removing the card from a MOBOTIX camera and then reboot the camera.

If the MicroSD card's contents are encrypted, you need to enter the same password in the "new" camera in the **Admin Menu > Storage on External File Server / Flash Device** dialog box. Otherwise, the camera cannot access the MicroSD card.

3.5.7 Limitations On Warranty When Using Flash Storage Media

MOBOTIX will not assume any responsibility for flash storage devices (for example, MicroSD cards or connected USB storage devices) delivered with or integrated into MOBOTIX cameras. The same applies to damage to flash storage devices or damage resulting from the use of devices that are not supplied by MOBOTIX.

3.6 Configuration In The Browser

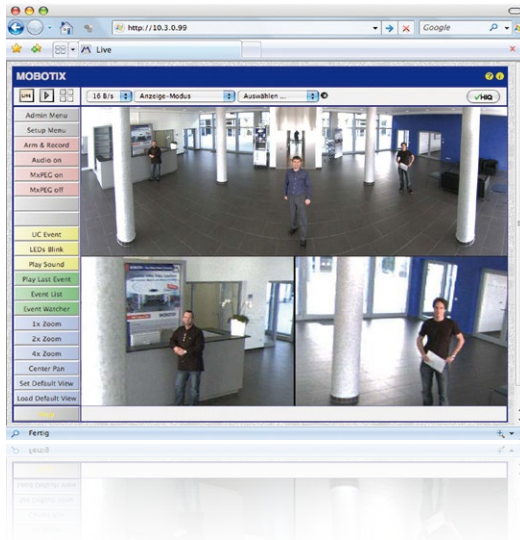

3.6.1 Overview

A MOBOTIX camera can be completely configured using a JavaScript-enabled browser on all common operating systems (such as Windows, Linux, Macintosh, etc.). The camera provides a HTML-based user interface for this purpose. The camera executes the changes you make to the camera configuration via HTTP commands using programs and scripts of the embedded software. The settings are stored in the camera's flash memory.

This section contains an overview of the general browser settings of the MOBOTIX camera, as well as further configuration options. Detailed information on the software functions is provided in the camera's online help.

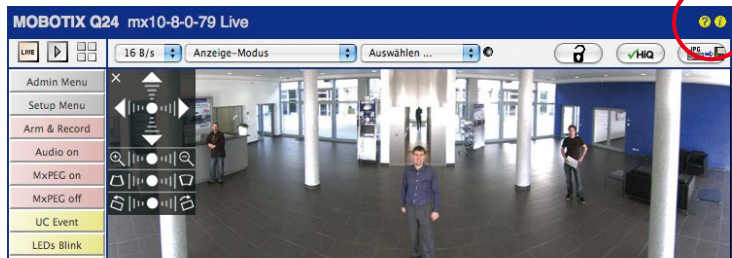

Basic Settings

- **Administering the camera:** You can modify the camera configuration in the Admin Menu or the Setup Menu.
 - **Admin Menu:** This menu contains the basic configuration dialog boxes of the camera (for example, passwords, interfaces, software updates).
 - **Setup Menu:** This menu contains the dialog boxes for configuring the image, event and recording parameters. Some of these settings can be changed using the corresponding Quick Controls in the live view.
- **Resetting changes:** If you would like to reset some larger changes in one dialog box without resetting the complete configuration, you can use the **Default** button at the bottom of the dialog box to reset only this dialog box's settings to the factory settings. If you would like to reset all image settings, you can do so using the **Manage Settings > Restore Image Settings** Quick Control in the live image of the camera.
- **Storing changes permanently:** Once you have finished configuring the camera, you should always store the settings in the camera's permanent memory. You can do so in each dialog box (clicking on the **Set** button at the bottom of each dialog box will temporarily implement the change; when you click **Close**, you will be asked to store the complete configuration in the camera's permanent memory) or in the Admin Menu (**Admin Menu > Store current configuration into flash memory**). The **Configuration** section of the Admin Menu provides more functions for storing, copying and managing camera settings. For more information on this topic, refer to the online help for the specific dialog boxes.
- **Time tasks and time synchronization:** Apart from a multitude of possibilities for controlling the camera using time (time tables, holiday and vacation, scheduled tasks, etc.), the camera can also synchronize its internal clock. This allows you to manually synchronize the camera with a computer or automatically using a time server or another MOBOTIX camera. The camera can use either NTP servers or Time Protocol servers. For more information on this topic, refer to the online help for the specific dialog boxes.
- **The "More" and "Less" buttons:** When opening some of the camera dialog boxes, the camera only shows the most important parameters. These dialog boxes have a **More** button in the bottom right-hand corner. Click it to display additional options. If all options are displayed, click on the **Less** button to hide the additional options.

User name: **admin**
password: **meinsm**

Admin Menu

Setup Menu

Make sure to permanently store changed parameters

Automatic time synchronization using a time server

More: Display advanced features

Less: Hide advanced features

3.6.2 General Browser Settings

- **Run the Quick Installation:** After booting the MOBOTIX camera for the first time, accessing the administration menu (the **Admin Menu** button) will automatically start the Quick Installation. The Quick Installation assistant helps you in setting the most important parameters of the camera. For security reasons, you should set your own administrator password and disable public access to the camera.
- **Disable public access:** Guest users are only allowed to access the Guest screen of the camera without entering a password. If this is not required, you should deactivate public access (**Admin Menu > Quick Installation** or **Admin Menu > Users and Passwords**).
- **Add users and assign access rights:** You can add users and user groups and assign the desired rights (**Admin Menu > Users and Passwords**, **Admin Menu > Group Access Control Lists (ACL)**), similar to a computer operating system. This approach allows individual access rights to be assigned or denied to camera-specific features based on the user groups.
- **Deactivate the automatic reboot:** In its factory state, every MOBOTIX camera will automatically reboot every morning at 3:36 a.m. All images in the camera's storage buffer will be deleted during this reboot. Images stored on external file servers, internal flash storage, or SD cards will NOT be affected by this reboot. Make sure that you deactivate the automatic reboot if this is not desired (**Admin Menu > Time Tasks**).
- **Optimize the image settings:** The factory image settings of MOBOTIX cameras deliver excellent images for most application scenarios and should not be changed. If you do wish to make changes, your changes should be minor and gradual. You should, however, set an image program according to the application scenario of the camera. Image programs provide a quick and simple method for adjusting the camera to the application scenario as they perform several configuration steps at once (**Image Programs Quick Control**).
- **Set the resolution of the live image:** By factory default, all MOBOTIX cameras are delivered with an image resolution of 640 x 480 pixels. You can select the desired resolution using the **Resolution Quick Control**.
- **Adjust the exposure:** The automatic exposure control of the MOBOTIX camera uses individually configurable windows to determine the best image exposure. Open the **Exposure Control Quick Control** and select a predefined set of exposure windows. If required, you can also define custom exposure windows (**Setup Menu > Exposure Settings**).
- **Activate event control and recording:** By factory default, the MOBOTIX camera's event control is disabled. Click on the **Arm & Record** button to activate event control. This will activate motion detection and recording. Cameras with integrated flash memory (MOBOTIX R models and models with SD card) will use the flash memory by default to store the image and video data (recording target). If desired, you can set additional events and adjust the settings of the recording and storage parameters (**Setup Menu > Event Settings**, **Setup Menu > Recording** and **Admin Menu > Recording to External File Server/Flash Device**).

- **Set up actions/messaging:** Upon detecting an event, the MOBOTIX camera can trigger alarms. These alarms can be adjusted to your needs and you can assign them to one or more events: playing back an alarm sound on the camera speaker, showing the visual alarm in the camera live image, sending an e-mail or IP Notify with the alarm image, placing a phone call, uploading an alarm image to an FTP server, switching a signal output line of the camera (for example, for switching on the lights/opening a door).

For the settings, see **Setup Menu > Action Group Overview**. The actions to be performed are defined and used in these action groups in the form of "action profiles." The different action profiles can also be defined in the following areas: Admin Menu in the Hardware Configuration (profiles for signal output), Transfer Profiles (FTP, e-mail, IP Notify) and Sound and VoIP Telephony (sound profiles, VoIP profiles). For more information, refer to the online help for the **Action Group Overview** dialog box.

- **Activate shock detector:** The M15 is also equipped with a shock detector as standard (for all IT and Secure models). If, for example, the camera's housing receives a blow, it automatically registers it and sends a notification via an IP Notify or telephone call. A general advantage is that MOBOTIX cameras are extremely tough, not least because of the absence of mechanical moving parts. This typically allows them to stay fully operational, in particular, when they are subject to strong vibrations. Open the **Setup Menu > Event Control > Environment Events > Edit** dialog box if you would like to activate the shock detector (and any other sensors).

3.6.3 Configuring the M15D-Thermal in the Browser

Modifying the Display Options of the Thermal Image Sensor

By factory default, the color palette for displaying the thermal image sensor has been set to *Grayscale* and the palette is shown at the bottom of the image. In order to change the display of the thermal sensor, open the **Setup Menu > Thermal Sensor Settings** dialog in the browser, select a different palette in the **Color Palette** dropdown and click on **Set**. Use the **Show Color Palette** option to control whether or not the palette is shown at the bottom of the image. See the **Thermal Sensor Settings** help page for further information on the available options.

Events Used by the Thermal Image Sensor

Only the **Video Motion** and **MxActivitySensor** events are available for the thermal image sensor. These events can be configured in the **Setup Menu > Event Overview** dialog in the **Image Analysis Events** section. By design it is not possible to recognize illumination events on the thermal sensor. For the same reason, there aren't any exposure settings for this type of image sensor.

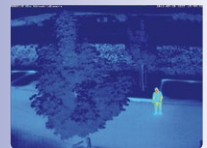



Blind module

The microphone can be irreversibly deactivated!

3.7 Additional Notes

3.7.1 Operation with Only One Sensor Module

If the MOBOTIX M15 is used with **only one sensor module**, **the blind module needs to be installed** (item 1.4 in Section 1.3, «Delivered Parts and Dimensions»)! If this is not the case, the camera must not be used (see Section 2.2.1, «Initial Installation of the Sensor Modules (except M15D-Sets)»).

3.7.2 Password For The Admin Menu

Accessing the Admin Menu of the camera (the Admin Menu softbutton) is only possible after entering a user name and password.

- Factory default user name is **admin**.
- Factory default password is **meinsm**.

The Quick Installation assistant automatically appears when the Admin Menu is accessed for the first time. It provides an easy method to adjust the basic camera settings to the current application scenario. For security reasons, we highly recommend changing the default administrator password after the camera has been properly configured.

Enter the user name and password exactly as shown above. Note that all entries are case-sensitive.

Caution

Make sure that you store information on **user names and passwords** in a secure place. If you lose the administrator password and cannot access the administration menu, the password can only be reset at the factory. This service is subject to a fee!

3.7.3 Permanently Deactivating The Microphone

Deactivating a camera's microphone may be necessary in order to protect the privacy of persons at a workplace or for other reasons. You can permanently and irreversibly deactivate the microphone in the **Admin Menu > Loudspeaker and Microphone** dialog box.

Caution

This **deactivation occurs in the camera module itself and cannot be reversed**, even at the factory. Deactivating the microphone will also deactivate all functions that are making use of the microphone.

Additional Notes

3.7.4 Starting The Camera With The Factory IP Address

If the camera's IP address is not known, you can start the camera with its factory IP address. This procedure is described in detail in *Section 3.2.5, «Starting The Camera With The Factory IP Address»*.

3.7.5 Resetting The Camera To Factory Settings

All settings of the MOBOTIX camera can be reset permanently to the factory default settings. This makes sense if you have, for example, obtained a camera without any information or you would like to reset all settings after testing the camera. In order to perform this procedure, you need to have administrative access to the camera (admins group). Open **Admin Menu > Reset** to reset the camera to factory defaults.

Note

All defined users are deleted and the admin password is reset to the factory default when you reset the camera using **Admin Menu > Reset**. Use the method described in *Section 3.2.5, «Starting The Camera With The Factory IP Address»* if you would like to maintain the existing users.

3.7.6 Activating Event Control And Motion Detection

In its default configuration, the camera's event control and video motion detection features are not enabled. In order to activate event-controlled recording, open **Setup Menu > General Event Settings** and activate the Arming switch. Another method is to click on the **Arm & Record** softbutton in the browser's user interface. The camera displays the motion detection window in the live image (dotted frame in the center) and the camera automatically stores images as soon as the motion detection window detects movements.

3.7.7 Deactivating Text And Logo Options

As camera arming is deactivated in the camera's default configuration (see preceding section), the MOBOTIX camera only displays the text **www.mobotix.com**, the time stamp and the MOBOTIX logo at the top of the image. Once the camera arming has been activated, the text at the bottom of the live image (event, action, messaging and recording symbols) will also appear.

You can deactivate the status bar at the bottom of the live image and the text bar in the top left-hand corner by setting Text Display in the **Setup Menu > Text & Display Settings** dialog box to **Off**. Setting Text Display to **Date and Time** will only display the time stamp in the live image. To hide the logo in the live image, open **Admin Menu > Logo Profiles** and set **Logo Display** to **Deactivated**.

You can reset specific parts of the configuration

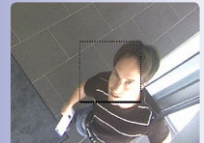

If the dotted rectangle in the live image is visible, the camera is armed

Text and logos can be also deactivated or individually configured

3.7.8 Deactivating The Camera Reboot

By factory default, the MOBOTIX camera automatically reboots once a week between 3 a.m. and 4 a.m. The reason for this is that in some rare cases, external influences (for example, radiation at high altitudes) can sometimes lead to camera malfunctions. The automatic reboot will refresh the camera's memory and will ensure proper operation without requiring any interaction on the part of the user. If desired, you can deactivate the automatic reboot of the camera in the **Admin Menu > Time Tasks** dialog box.

3.7.9 Browser

Current Internet browsers (Internet Explorer, Mozilla Firefox, Safari, Google Chrome, Opera, etc.) with enabled JavaScript can display the camera's live images with their standard settings.

3.7.10 Cleaning The Camera And Lens

If the lens becomes dirty during the installation process, clean the lens using a lint-free cotton cloth. Make sure that the lens is still in focus after cleaning and adjust its focus if required.

Cleaning Domes, Lenses and Filters

- Always mount and unmount the dome using the blue lens wrench (M.6) in order to protect it from being scratched and from getting dirty.
- Use the wide side of the black module wrench (M.7) for mounting/unmounting lens protection covers/filters. The slim side of the wrench is used to adjust the focal length (sharpness) of all lenses (except L12).
- You should clean the dome at regular intervals. Always use a soft, lint-free cotton cloth for this purpose.
- If the dirt is more persistent, add a mild alcohol-free detergent without abrasive particles.
- Make sure you instruct cleaning personnel on how to clean the camera.



M.6



M.7

3.7.11 Legal Notes

Attention – Special Export Regulations Apply! Cameras with thermal image sensors (“thermal cameras”) are subject to the special export regulations of the U.S.A. and the ITAR (International Traffic in Arms Regulation):

- According to the currently applicable export regulations of the U.S.A. and the ITAR, cameras with thermal image sensors or parts thereof must not be exported to countries embargoed by the U.S.A. or the ITAR. At present, this applies to the following countries: Syria, Iran, Cuba, North Korea and Sudan. The same export ban applies to all persons and institutions listed in “The Denied Persons List” (see www.bis.doc.gov, “Policy Guidance > Lists of Parties of Concern”).
- Under no circumstances can the camera itself or its thermal image sensors be used in the design, the development or in the production of nuclear, biological or chemical weapons or in the weapons themselves.

Legal aspects of video and sound recording: You must comply with all data protection regulations for video and sound monitoring when using MOBOTIX products. Depending on national laws and the installation location of the M15, the recording of video and sound data may be subject to special documentation or it may be prohibited. All users of MOBOTIX products are therefore required to familiarize themselves with all valid regulations and comply with these laws. MOBOTIX AG is not liable for any illegal use of its products.

3.7.12 Safety Warnings

Installation Instructions:

- This product must not be used in locations exposed to the dangers of explosion.
- Make sure to install this product as shown in *Chapter 2, «Installation»* of this manual.
- When installing this product, make sure that you are only using genuine MOBOTIX parts and MOBOTIX connection cables.
- Make sure that you are installing this product on a solid surface that provides for a sturdy installation of the fixing elements used.

Electrical installation: Electrical systems and equipment may only be installed, modified and maintained by a qualified electrician or under the direction and supervision of a qualified electrician in accordance with the applicable electrical guidelines. Make sure to properly set up all electrical connections.

Electrical surges: MOBOTIX cameras are protected against the effects of small electrical surges by numerous measures. These measures, however, cannot prevent the camera from being damaged when stronger electrical surges occur. Special care should be taken when installing the camera outside of buildings to ensure proper protection against **lightning**, since this also protects the building and the whole network infrastructure.

Max. power consumption of attached extension modules: The power consumption of all attached *MxBus modules* must **not exceed 3 W**. When attaching modules to the MxBus connector **and** the USB connector, the **power consumption of all attached mod-**







ules must not exceed 4 W, if the camera is powered by PoE class 3. If **PoE class 2** is used, **the power consumption of all attached modules must not exceed 1 W!**

Never touch the dome or the protective lens covers: Due to the high performance of the M15, the area of the image sensor **can get quite hot**, especially when the ambient temperature is also high. This does not affect the proper functioning of the camera in any way. For this reason, the product must not be installed within the reach of persons without domes or protective lens covers.

Only exchange sensor module when powered off: Make sure the power supply to the camera is disconnected before installing or replacing sensor modules.

Network security: **MOBOTIX** products include all of the necessary configuration options for operation in Ethernet networks in compliance with data protection laws. The operator is responsible for the data protection concept across the entire system. The basic settings required to prevent misuse can be configured in the software and are password-protected. This prevents unauthorized parties from accessing these settings.

3.7.13 Online Help In The Browser

For more information, see the News and Functional Overview pages in the online help of the camera's browser interface. Click on the  icon to open the camera's online help. Furthermore, detailed information on the camera and its current configuration is displayed in the **Camera Status** dialog box when you click on the  icon.

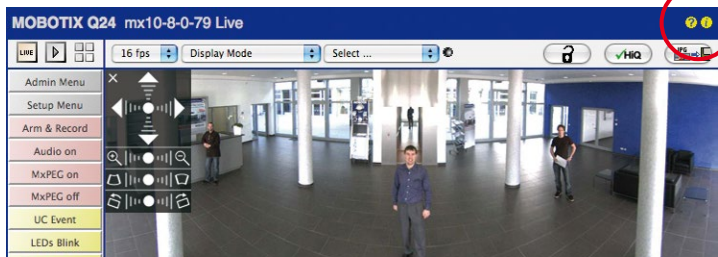

3.7.14 RoHS Declaration

The products of **MOBOTIX AG** are in full compliance with Art. 5 of the German Electrical and Electronic Equipment Act and the E. U. Directive 2002/95/EC on the Restriction of the Use of Certain Hazardous Substances in Electrical and Electronic Equipment (RoHS) as far as they are subject to these regulations. (You can find the **MOBOTIX RoHS Declaration** under www.mobotix.com, **Support > Spec Sheets**).

3.7.15 Disposal

Electrical and electronic products contain many reusable materials. For this reason, we would ask that you dispose of MOBOTIX products at the end of their service life in accordance with all legal requirements and regulations (or deposit these products at a municipal collection center). MOBOTIX products may not be disposed of with household waste! If the product contains a battery, please dispose of the battery separately (the corresponding product manuals contain specific directions if the product contains a battery).



3.7.16 Disclaimer

MOBOTIX AG does not assume any liability for damage that is the result of improper use of its products or failure to comply with the operating manuals or the applicable rules and regulations. Our **General Terms and Conditions** apply. You can download the current version at www.mobotix.com (using the COS link at the bottom of each page).



MOBOTIX - The HiRes Video Company



To demonstrate our confidence in the quality of our products, MOBOTIX cameras have been used to capture all images that appear in this manual.

Manufacturer

MOBOTIX AG
Kaiserstrasse
67722 Langmeil, Germany
Germany

Tel: +49 6302 9816-103
Fax: +49 6302 9816-190

<http://www.mobotix.com>
sales@mobotix.com

Executive Board

Dr. Magnus Ekerot
Registration Office: Kaiserslautern Local Court
Registration Number: HRB 3724
Tax Code: 44/676/0700/4
Tax Office: Worms-Kirchheimbolanden, Germany

VAT ID:
DE202203501

You can find the latest version of this document at www.mobotix.com in the **Support** section.



Technical specifications subject to change without notice!



Dual. Modular. Unique.

True to the original: The weatherproof, robust successor to our successful MOBOTIX dual camera features interchangeable sensor modules as well as the latest MOBOTIX system technology. As a result, it remains totally unique in terms of performance, functionality and design.

2x L12 to L160 Day or Night



1x L12 to L160 Day or Night



1x Thermal, 1x L12-L160



5MP
Sensor

MxLEO



HiRes Video Innovations

The German company MOBOTIX AG is known as the leading pioneer in network camera technology and its decentralized concept has made high-resolution video systems cost efficient.

MOBOTIX AG • D-67722 Langmeil • Tel: +49-6302-9816-103 • Fax: +49-6302-9816-190 • sales@mobotix.com